





## [ QR CODE ]

\* If a problem occurs, enter the appropriate QR code. Once connected, you can watch a YouTube video about the inspection details.

NO	DEFECT SYMPTOM	QR CODE
1	E.31 GOAL KEEPER MOTOR ERROR	E.31 
2	E.41 BALL MOUNTING MOTOR ERROR	E.41 
3	E.71, 72 GOAL IN HOLE SENSOR ERROR	E.71, 72 
4	SOLENOIDE ERROR	SOLENOIDE 

**\* ANDAMIRO WARRANTIES the parts from date of shipment as follows.**











**- One Year Limited Warranty : Electronic Boards**







**- 6 Month Limited Warranty : Moving Parts**







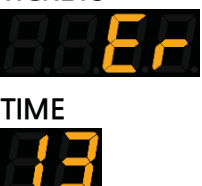

## **CONTENTS**

1. ERROR CODE	.....P03
2. TEST MODE	.....P06
3. TROUBLESHOOTING	.....P10
4. WARRANTY ITEM & PART PICTURE	.....P22





# [ 1. ERROR CODE ]











ERROR CODE			
ERROR CODE FND DISPLAY	ERROR TYPE	DESCRIPTION	CHECK POINTS
TICKETS TIME 	SYSTEM	PROBLEM AT MAIN BOARD BACK-UP MEMORY (FRAM)	REPLACE MAIN BOARD IF PROBLEM IS STILL NOT FIXED AFTER TURNING POWER OFF AND ON
TICKETS TIME 		PROBLEM AT SETUP STORAGE DATA	1. PERFORM FACTORY SETTING 2. CHECK SET UP AND SAVE 3. REPLACE MAINBOARD IF PROBLEM IS STILL NOT FIXED
TICKETS TIME 		PROBLEM AT GAME STORAGE DATA	REPLACE MAIN BOARD IF PROBLEM IS STILL NOT FIXED AFTER TURNING POWER OFF AND ON
TICKETS TIME 	COIN SELECTOR	CONTINUOUS SENSOR SIGNAL AT COIN SELECTOR 1	1. OPERATION CHECK OF COIN SELECTOR 1 2. SENSOR INPUT CHECK OF COIN SELECTOR 1
TICKETS TIME 		CONTINUOUS SENSOR SIGNAL AT COIN SELECTOR 2	1. OPERATION CHECK OF COIN SELECTOR 2 2. SENSOR INPUT CHECK OF COIN SELECTOR 2
TICKETS TIME 	BILL ACCEPTER	CONTINUOUS SENSOR SIGNAL AT BILL ACCEPTER	1. OPERATION CHECK OF BILL ACCEPTER 2. SENSOR INPUT CHECK OF BILL ACCEPTER
TICKETS TIME 	GOAL KEEPER MOTOR	PROBLEM AT GOAL KEEPER MOTION SENSOR SIGNAL (NO SENSOR SIGNAL OR CONTINUOUS SIGNAL)	1. CHECK MOTOR OPERATION STATUS 2. CHECK INPUT STATUS OF MOTION SENSOR
TICKETS TIME 	BALL MOUNTING MOTOR	PROBLEM AT BALL MOUNTING MOTION SENSOR SIGNAL (NO SIGNAL OR CONTINUS SIGNAL)	1. CHECK MOTOR OPERATION STATUS 2. CHECK OPERATION SENSOR INPUT STATUS
TICKETS TIME 	GOAL IN HOLE SENSOR	CONTINUOUS GOAL IN HOLE SENSOR SIGNAL	1. CHECK BALL JAMMING STATUS 2. CHECK GOAL IN HOLE SENSOR STATUS
TICKETS TIME 	GOAL IN HOLE SENSOR	GOAL CHECK PROBLEM DUE TO FAILURE OF THE GOLA IN HOLE SENSOR	1. CHECK GOAL IN HOLE SENSOR STATUS
TICKETS TIME 	TICKET DISPENSOR	NO TICKET IN TICKET DISPENSOR	1. CHECK TICKET DISPENSOR









ERROR CODE ERROR DETECTION METHOD			
ERROR CODE FND DISPLAY	ERROR TYPE	DESCRIPTION	CHECK POINTS
TICKETS 	SYSTEM	PROBLEM AT SETUP STORAGE DATA	ERROR OCCURS IF THERE IS ANY PROBLEM READING SET UP BACK UP MEMORY AFTER POWER IS TURNED ON
TICKETS 		PROBLEM AT GAME STORAGE DATA	ERROR OCCURS IF THERE IS ANY PROBLEM READING GAME BACK UP MEMORY AFTER POWER IS TURNED ON
TICKETS 	COIN SELECTOR	CONTINUOUS SENSOR SIGNAL AT COIN SELECTOR 1	ERROR OCCURS IF SIGNAL IS CONTINUED MORE THAN 2 SECONDS WHILE INHIBIT IS ON
TICKETS 		CONTINUOUS SENSOR SIGNAL AT COIN SELECTOR 2	
TICKETS 	BILL ACCEPTER	CONTINUOUS SENSOR SIGNAL AT BILL ACCEPTER	ERROR OCCURS IF SIGNAL IS CONTINUED MORE THAN 2 SECONDS WHILE INHIBIT IS ON
TICKETS 	GOAL KEEPER MOTOR	PROBLEM AT GOALKEEPER OPERATION SENSOR SIGNAL (NO SIGNAL OR CONTINUOUS SIGNAL)	ERROR IF THERE IS NO SENSOR SIGNAL MORE THAN 5 SECS WHILE MOTOR IS OPERATING













<p>TICKETS    TIME  </p>	<p>BALL MOUNTING MOTOR</p>	<p>PROBLEM AT BALL MOUNTING OPERATION SENSOR SIGNAL (NO SIGNAL OR CONTINUOUS SIGNAL)</p>	<p>IF THERE IS NO SENSOR SIGNAL FOR MORE THAN 3 SECONDS DURING MOTOR OPERATION, IT STOPS AND ROTATES IN REVERSE FOR 2 SECONDS AND THEN ROTATES FORWARD. IF THERE IS STILL NO SENSOR SIGNAL FOR 3 SECONDS DURING THIS PROCESS, ERROR OCCURS</p>
<p>TICKETS    TIME  </p>	<p>GOAL IN HOLE SENSOR</p>	<p>CONTINUOUS GOAL IN HOLE SENSOR SIGNAL</p>	<p>ERROR IF THERE IS GOAL IN HOLE SENSOR SIGNAL MORE THAN 3 SECONDS DURING GAME PLAY. ERROR IF THERE IS CONTINUOUS GOAL IN HOLE SENSOR SIGNAL DUE TO SENSOR PROBLEM</p>
<p>TICKETS    TIME  </p>	<p>GOAL IN HOLE SENSOR</p>	<p>GOAL CHECK PROBLEM DUE TO FAILURE OF THE GOAL IN HOLE SENSOR</p>	<p>IN CASE OF THE NUMBER OF GOAL CHECKS IS HIGHER THAN THE NUMBER OF TIMES THE BALL IS FIRED</p>
<p>TICKETS    TIME  </p>	<p>TICKET DISPENSOR</p>	<p>NO TICKET IN TICKET DISPENSOR</p>	<p>ERROR IF THERE IS NO TICKET OUT SIGNAL MORE THAN 3 SECONDS AFTER TICKET OUT SIGNAL TO TICKET DISPENSOR</p>

## [ 2. TEST MODE ]















TEST MODE - OPERATION TEST ※ TEST MODE HOW TO OPERATE SELECT CHECK BUTTON			
1	2	3	4
 MENU/SELECT	 MOVE/CHANGE	 or  MENU/SELECT      SHOOT	 CANCEL/SERVICE
ENTER SETUP MODE	MOVE TO TEST MENU ITEM	OPERATE TEST ITEM ON/OFF	EXIT (TO PREVIOUS MENU)



TEST ITEM	FND DISPLAY	DESCRIPTION
51. INPUT TEST	TICKETS  TIME 	<b>CHECK INPUT STATUS OF BUTTON AND SENSOR</b> (TO BE PLAYED BY SOUND WHEN INPUT STATUS OF EACH BUTTON AND SENSOR IS CHECKED) BASICALLY INPUT STATUS NUMBER IS DISPLAYED IN THE 1ST PLACE OF TIME FND
	TIME 	0. SETUP MENU/SELECT BUTTON [Sound: ZERO]
	TIME 	1. LEFT SHOOT BUTTON [Sound: ONE]
	TIME 	2. RIGHT SHOOT BUTTON [Sound: TWO]
	TIME 	3. GOAL IN HOLE SENSOR [Sound: THREE]
	TIME 	4. BALL MOUNTING SENSOR [Sound: FOUR]
	TIME 	5. COIN SELECTOR SENSOR 1 [Sound: FIVE]
	TIME 	6. COIN SELECTOR SENSOR 2 [Sound: SIX]
	TIME 	7. BILL ACCEPTER SIGNAL [Sound: SEVEN]
	TIME 	DISPLAY OF INPUT STATUS IN THE 2ND PLACE OF TIME FND 9. GOALKEEPER MOTOR CHECK SENSOR[Sound: NINE]

52. LAMP & FND	<p>TICKETS    TIME  </p>	<p><b>LAMP, FND, LED TEST</b>  SELECT or SHOOT BUTTON :TEST BY PRESSING IN SEQUENCE OF [STEP] ▶ [ON] ▶ [ON/OFF] ▶ [OFF]</p>
		<p>[STEP] : TEST IN SEQUENCE AS BELOW  ▶ LAMP : LEFT SHOOT BUTTON LAMP ON  ▶ LAMP : RIGHT SHOOT BUTTON LAMP ON  ▶ FND : TOTAL ON, OFF FLICKERING  ▶ FND : DISPLAY [12] [34] IN SEQUENCE  ▶ FND : DISPLAY TOTAL [11] [11] ~ [99] [99] NUMBER COUNT  ▶ LED : GREEN LED AT TABLE FLANGE ON  ▶ LED : FLICKERING OF GOAL IN HOLE ACRYL IN SEQUENCE OF WHITE, RED, GREEN, BLUE  [ON] : STATUS OF TOTAL LAMP, FND, LED ON  [ON/OFF] : ON/OFF TOTAL LAMP, FND, LED AT AN INTERVAL OF ONE SECOND  [OFF] : STATUS OF TOTAL OFF  (FND : DISPLAY OF CURRENT MENU ITEM [52] [--] )</p>
53. GOALKEEPER MOTOR	<p>TICKETS    TIME  </p>	<p><b>GOALKEEPER MOTOR TEST</b>  SELECT or SHOOT BUTTON :  MOTOR OPERATION "ON" / "OFF"</p>
	<p>TIME </p>	<p>DISPLAY OF MOTOR OPERATION STATUS IN THE 1ST PLACE OF TIME FND  [o-] : MOTOR ON, [--] : MOTOR OFF</p>
	<p>TIME </p>	<p>DISPLAY OF GOALKEEPER SENSOR CHECK COUNT IN THE 2ND PLACE OF TIME FND</p>
	<p>TIME </p>	<p>DISPLAY OF GOALKEEPER SENSOR ON/OFF IN THE 2ND PLACE OF TIME FND DOT</p>
54. TICKET	<p>TICKETS    TIME  </p>	<p><b>TICKET DISPENSER TEST</b>  SELECT OR SHOOT BUTTON : TICKET DISPENSER "ON" / "OFF"  (3 -&gt; 2 -&gt; 1 -&gt; 0 DISPENSED TICKETS, 3 TICKETS OUT</p>

55. SOLENOID	<p>TICKETS </p> <p>TIME </p>	<p><b>SOLENOID TEST</b>  SELECT BUTTON : AUTOMATIC OPERATION OF SOLENOID "ON", "OFF"  REPETITION OF OPERATION FROM LEFT SOLENOID TO RIGHT SOLENOID  LEFT SHOOT BUTTON : LEFT SOLENOID #1 "ON", "OFF"  RIGHT SHOOT BUTTON : RIGHT SOLENOID #1 "ON", "OFF"    TO PREVENT OVER LOAD AT SOLENOID TEST,  RETEST IS POSSIBLE AFTER WAITING ONE SECOND FROM SWITCHING ON  (WAIT FOR ONE SECOND AFTER SWITCHING ON)</p>
	<p>TIME </p>	<p>DISPLAY OF LEFT SOLENOID OPERATION STATUS 1 IN THE 1ST PLACE OF TIME FND.WHEN IT IS BEING OPERATED, LEFT SHOOT BUTTON LAMP IS SWITCHED ON</p>
	<p>TIME </p>	<p>DISPLAY OF RIGHT SOLENOID OPERATION STATUS 2 IN THE 2ND PLACE OF TIME FND. WHEN IT IS BEING OPERATED, RIGHT SHOOT BUTTON LAMP IS SWITCHED ON</p>
56. COIN	<p>TICKETS </p> <p>TIME </p>	<p><b>COIN SELECTOR TEST</b>  SELECT or SHOOT BUTTON : COIN SELECTOR OPERATION "ON" / "OFF". STATUS OF COIN SELECTOR "ON" IS DISPLAYED BY FLICKERING OF TIME/CREDIT(s) FND</p>
	<p>TIME </p>	<p>COIN SELECTOT 1 SENSOR CHECK COUNT IS DISPLAYED IN THE 1ST PLACE OF TIME FND.  STATUS OF COIN SELECTOR SENSOR IS DISPLAYED BY LEFT SHOOT BUTTON(On / Off)</p>
	<p>TIME </p>	<p>COIN SELECTOR 2 SENSOR CHECK COUNT IS DISPLAYED IN THE 2ND PLACE OF TIME FND  STATUS OF COIN SELECTOR SENSOR IS DISPLAYED BY RIGHT SHOOT BUTTON (On / Off)</p>
57. BILL	<p>TICKETS </p> <p>TIME </p>	<p><b>BILL ACCEPTER TEST</b>  SELECT or SHOOT BUTTON : BILL ACCEPTER OPERATION "ON" / "OFF". STATUS OF BILL ACCEPTER "ON" IS DISPLAYED BY FLICKERING OF TIME/CREDIT(s) FND</p>
	<p>TIME </p>	<p>DISPLAY OF BILL ACCEPTER SENSOR CHECK COUNT IN THE 2ND PLACE OF TIME FND</p>
	<p>TIME </p>	<p>DISPLAY OF BILL ACCEPTER SENSOR ON/OFF IN THE 2ND PLACE OF TIME FND DOT</p>



58. COUNTER	TICKETS 	<b>COUNTER TEST</b> SELECT or SHOOT BUTTON : COIN IN AND TICKET OUT COUNTER OPERATES AT AN INTERVAL OF ONE SECOND
	TIME 	
	TIME 	DISPLAY OF COIN IN COUNER OPERATION IN THE 1ST PLACE OF TIME FND
	TIME 	DISPLAY OF PRIZE OUT COUNER OPERATION IN THE 2ND PLACE OF TIME FND
59. SOUND	TICKETS 	<b>SOUND TEST</b> SELECT BUTTON : AUTOMATIC PLAY OF SOUND, ON/OFF TEST SHOOT BUTTON : PLAY OF SOUND (ONE TIME)
	TIME 	
	TIME 	DISPLAY OF SOUND PLAY "ON" IN THE TIME FND
60. BALL MOUNTED MOTOR	GOALS TIME 	<b>BALL MOUNTING MOTOR TEST</b> SELECT or SHOOT BUTTON : MOTOR OPERATION "ON" / "OFF"
	GOALS TIME 	
	TIME 	DISPLAY OF MOTOR OPERATION STATUS IN THE 1ST PLACE OF TIME FND [o-] : MOTOR ON, [--] MOTOR OFF
	TIME 	DISPLAY OF BALL MOUNTING MOTOR SENSOR CHECK COUNT IN THE 2ND PLACE OF TIME FND
	TIME 	DISPLAY OF BALL MOUNTING SENSOR ON/OFF STATUS IN THE 2ND PLACE OF TIME FND DOT
EXIT	TICKETS 	EXIT (TO PREVIOUS MENU)
	TIME 	

5. EXIT - EXIT TO OPERATION OPTIONS		
SETTING ITEM	FND DISPLAY	DESCRIPTION
5. EXIT	TICKETS  TIME 	EXIT TO OPERATION OPTIONS

# 3. TROUBLESHOOTING

\* General check up : Check the supply voltage and wiring connection properly  
 \* "NO" : Means faulty of the check up result.

## 1. IN CASE OF GOALKEEPER MOTOR PROBLEM [ Er. 31 ]

GOALKEEPER MOTOR

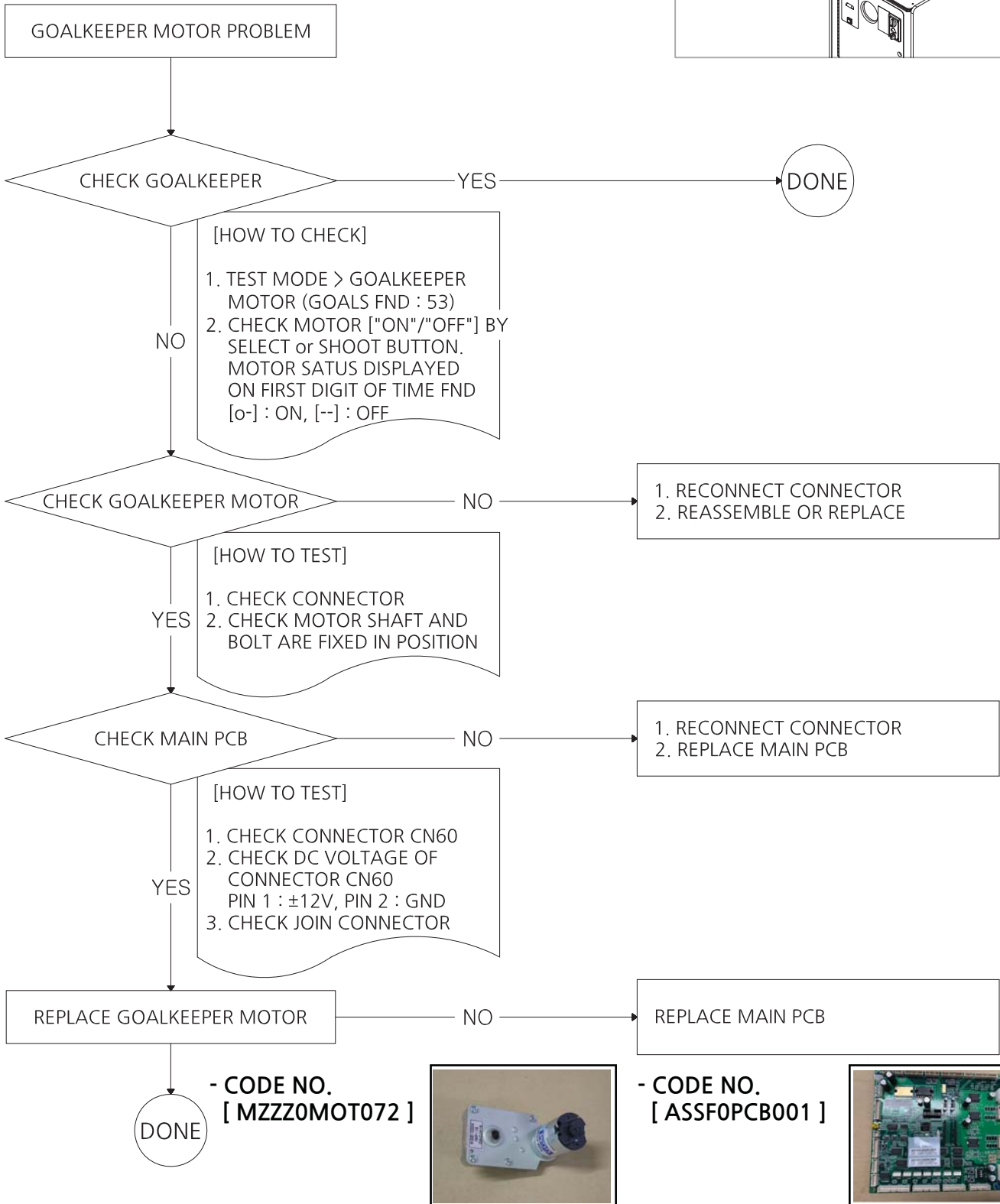
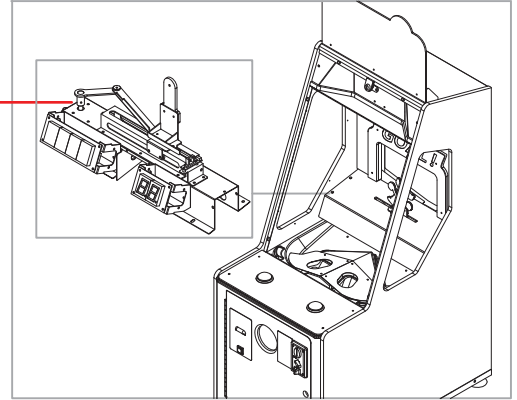

\* General check up : Check the supply voltage and wiring connection properly  
 \* "NO" : Means faulty of the check up result.

## 2. IN CASE OF GOALKEEPER SENSOR PROBLEM [ Er. 31 ]

GOALKEEPER SENSOR

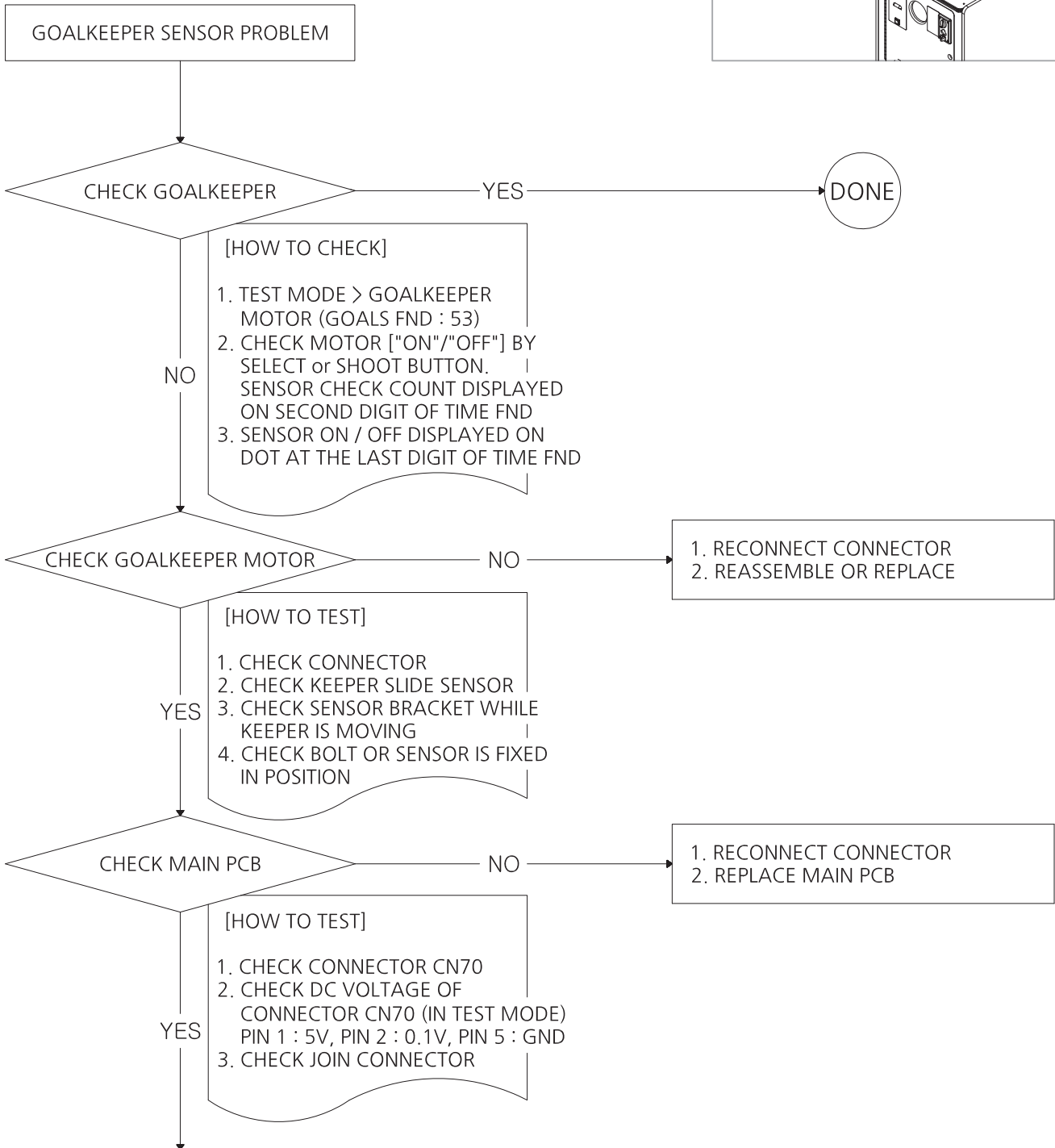
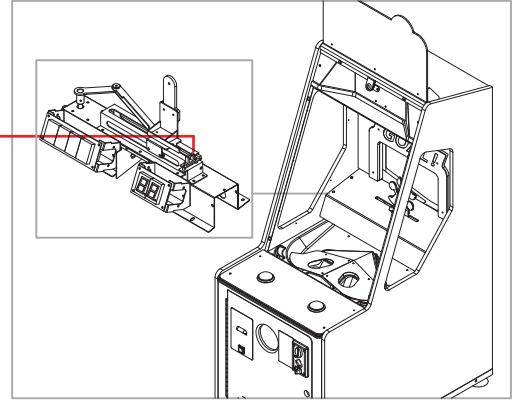

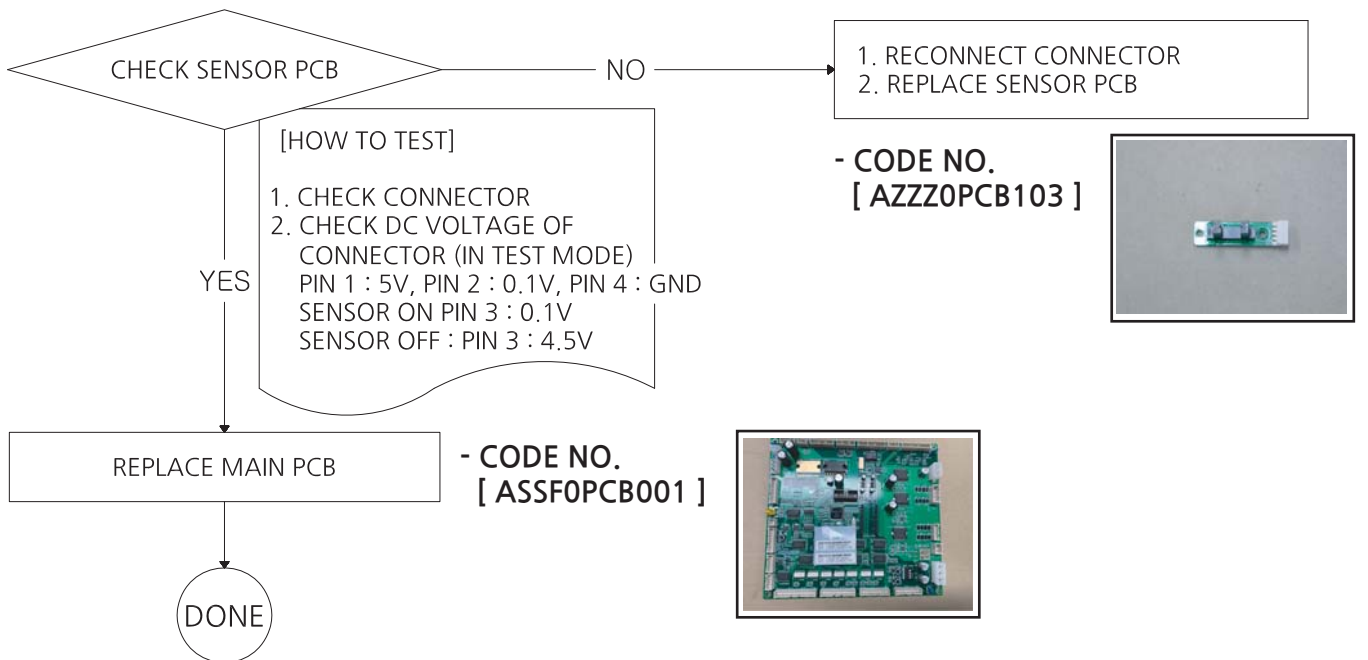

\* General check up : Check the supply voltage and wiring connection properly  
 \* "NO" : Means faulty of the check up result.

### 3. IN CASE OF BALL LOADING MOTOR PROBLEM [ ER. 41 ]

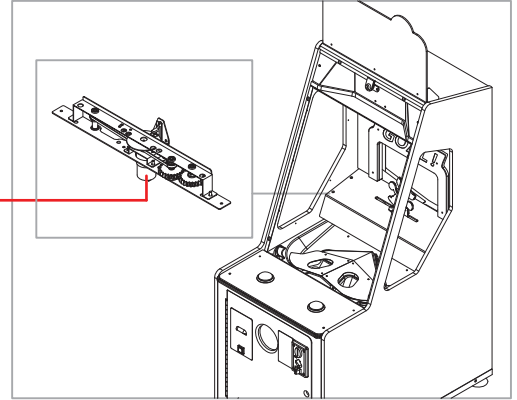

BALL LOADING MOTOR

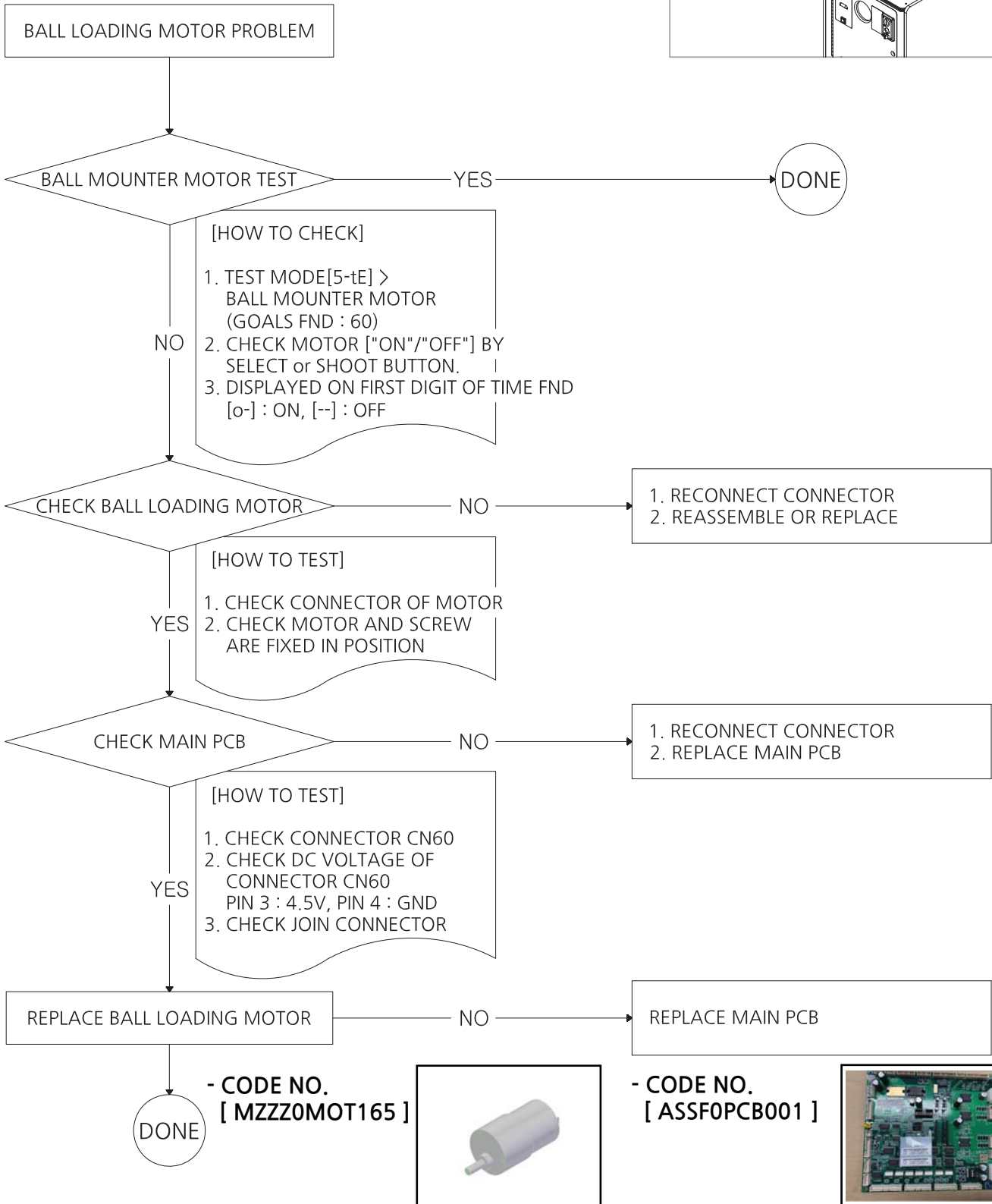

\* General check up : Check the supply voltage and wiring connection properly  
 \* "NO" : Means faulty of the check up result.

## 4. IN CASE OF BALL LOADING MOTOR SENSOR PROBLEM [ ER. 41 ]

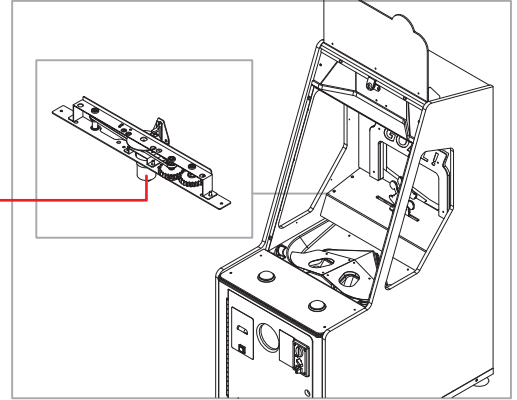

BALL LOADING MOTOR

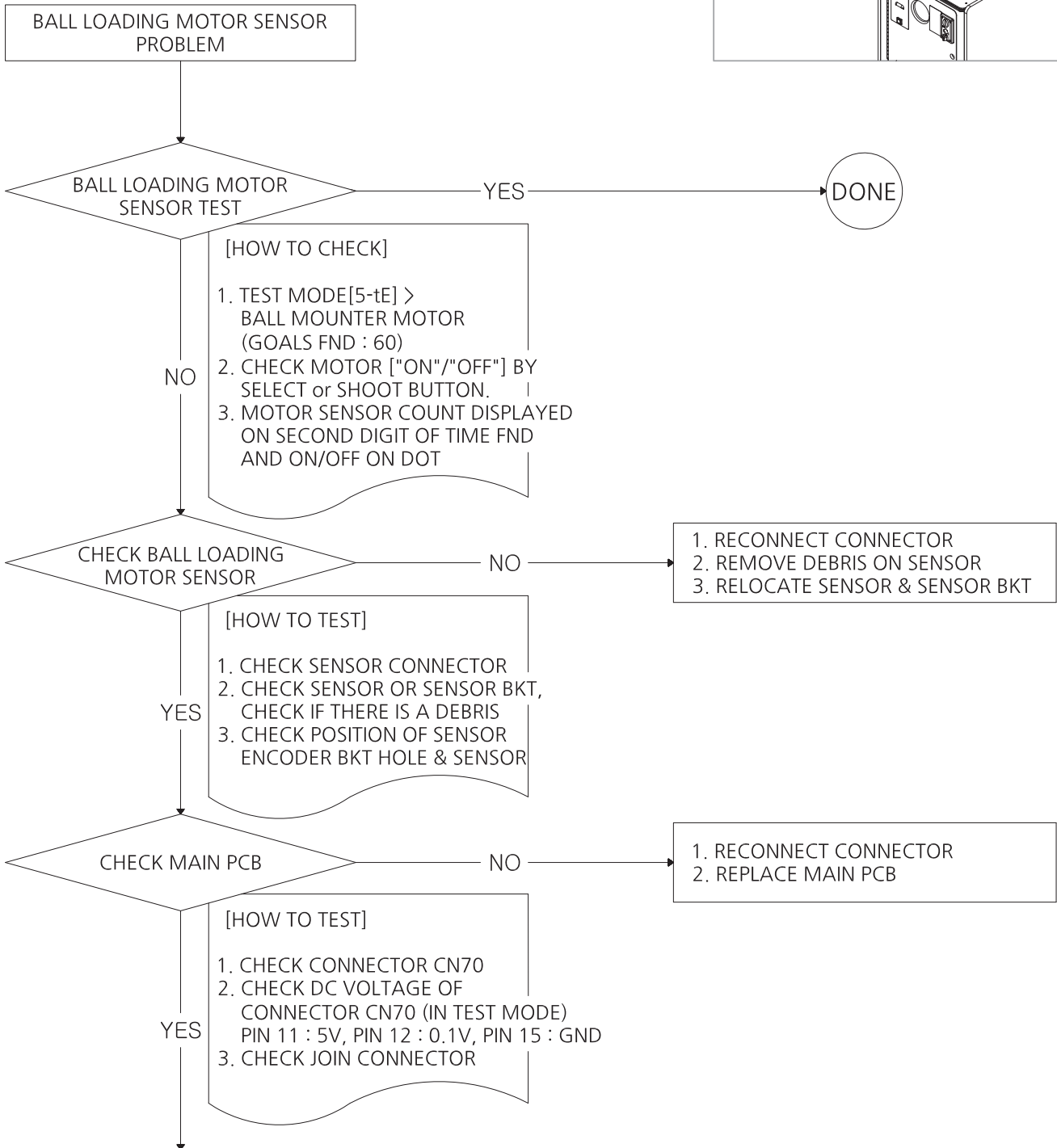

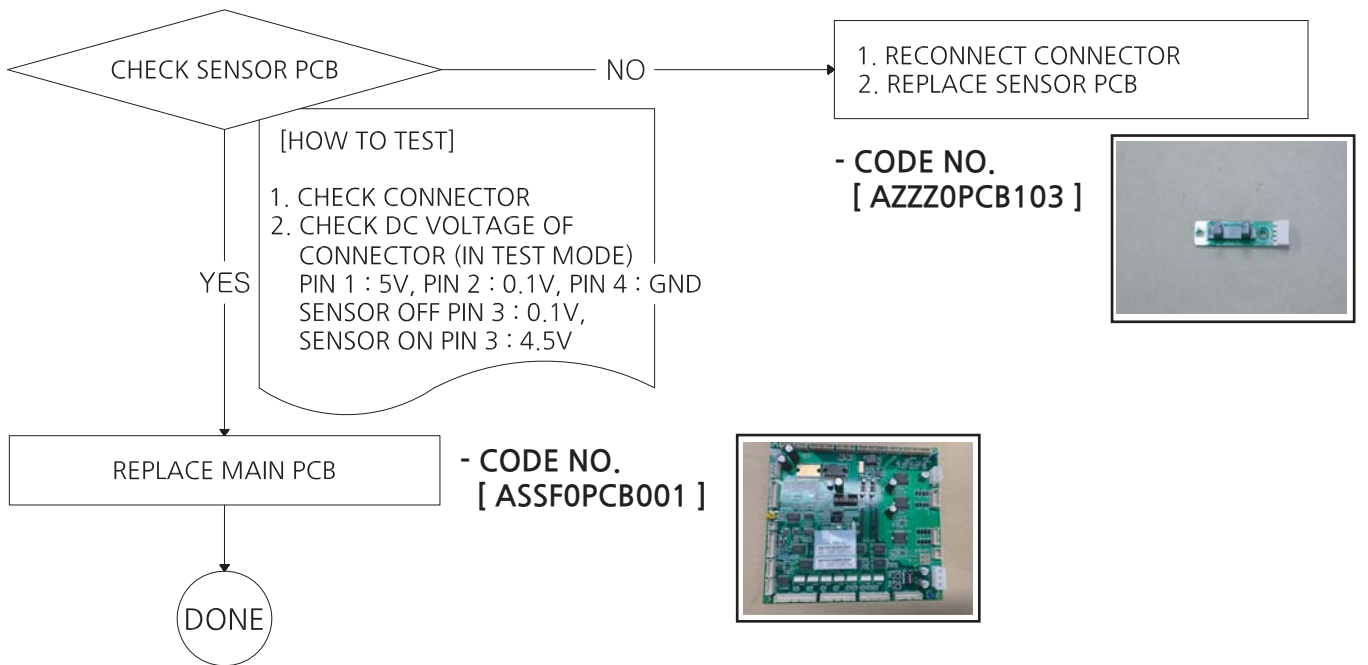

- \* General check up : Check the supply voltage and wiring connection properly
- \* "NO" : Means faulty of the check up result.

## 5. IN CASE OF GOAL IN HOLE SENSOR PROBLEM [ ER. 71, 72 ]

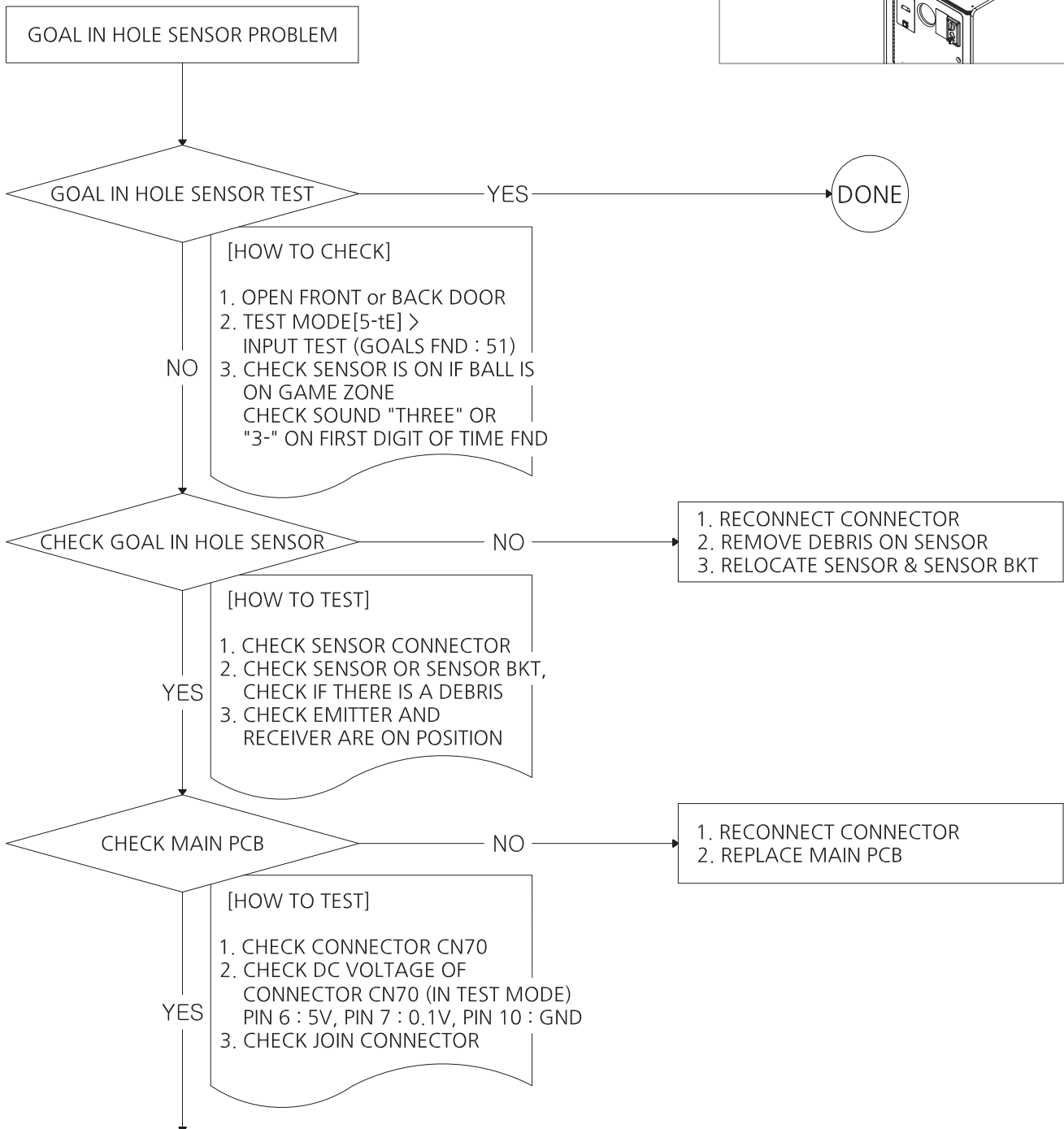
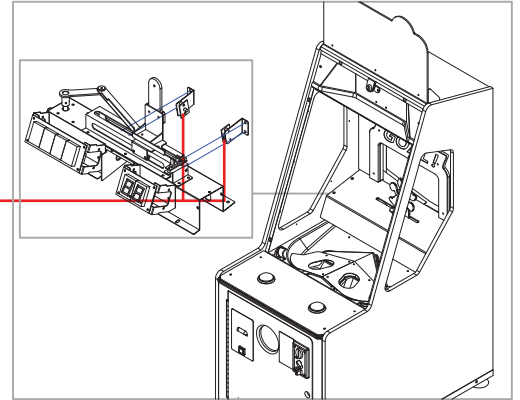



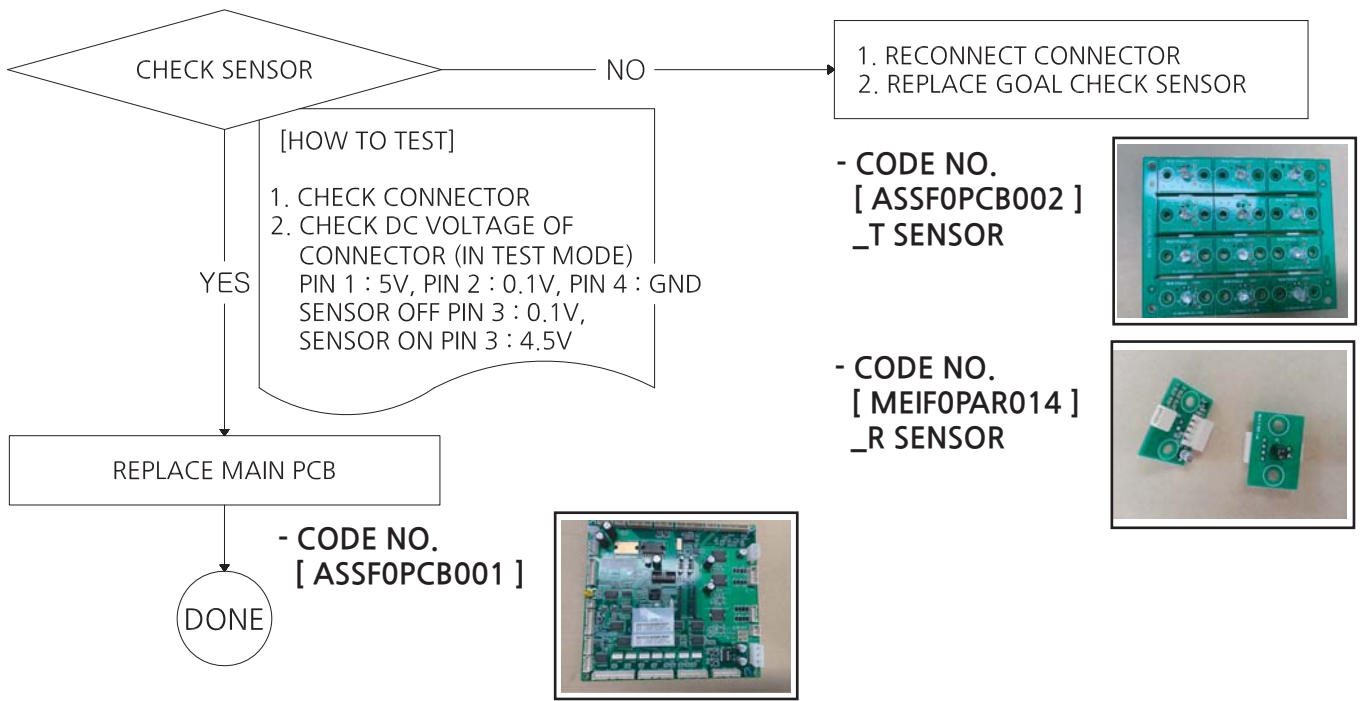

\* General check up : Check the supply voltage and wiring connection properly  
 \* "NO" : Means faulty of the check up result.

## 6. IN CASE OF SOLENOID LEFT PROBLEM

SOLENOID LEFT

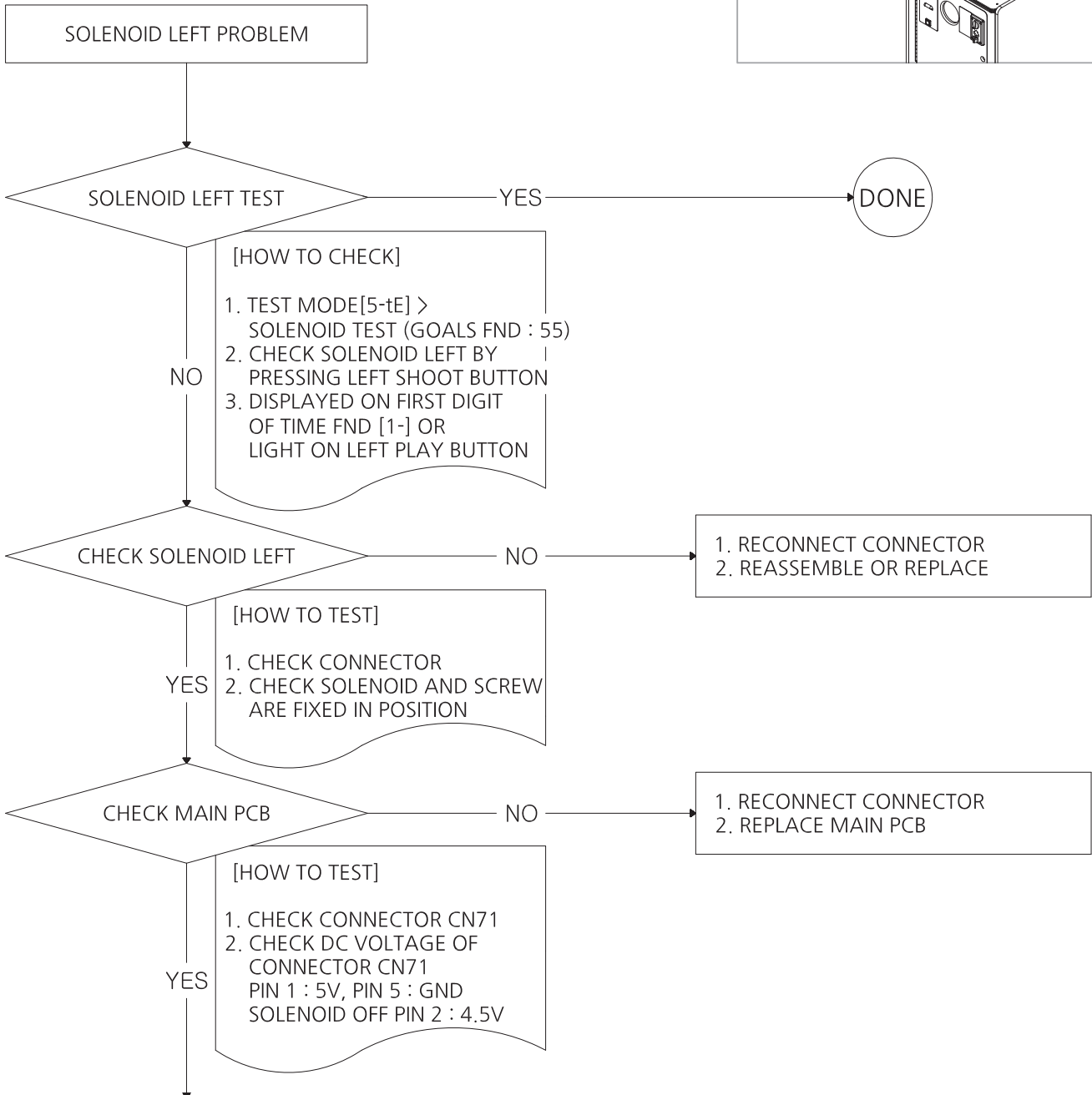
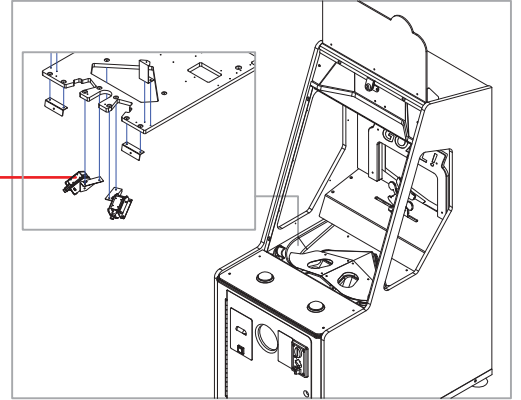

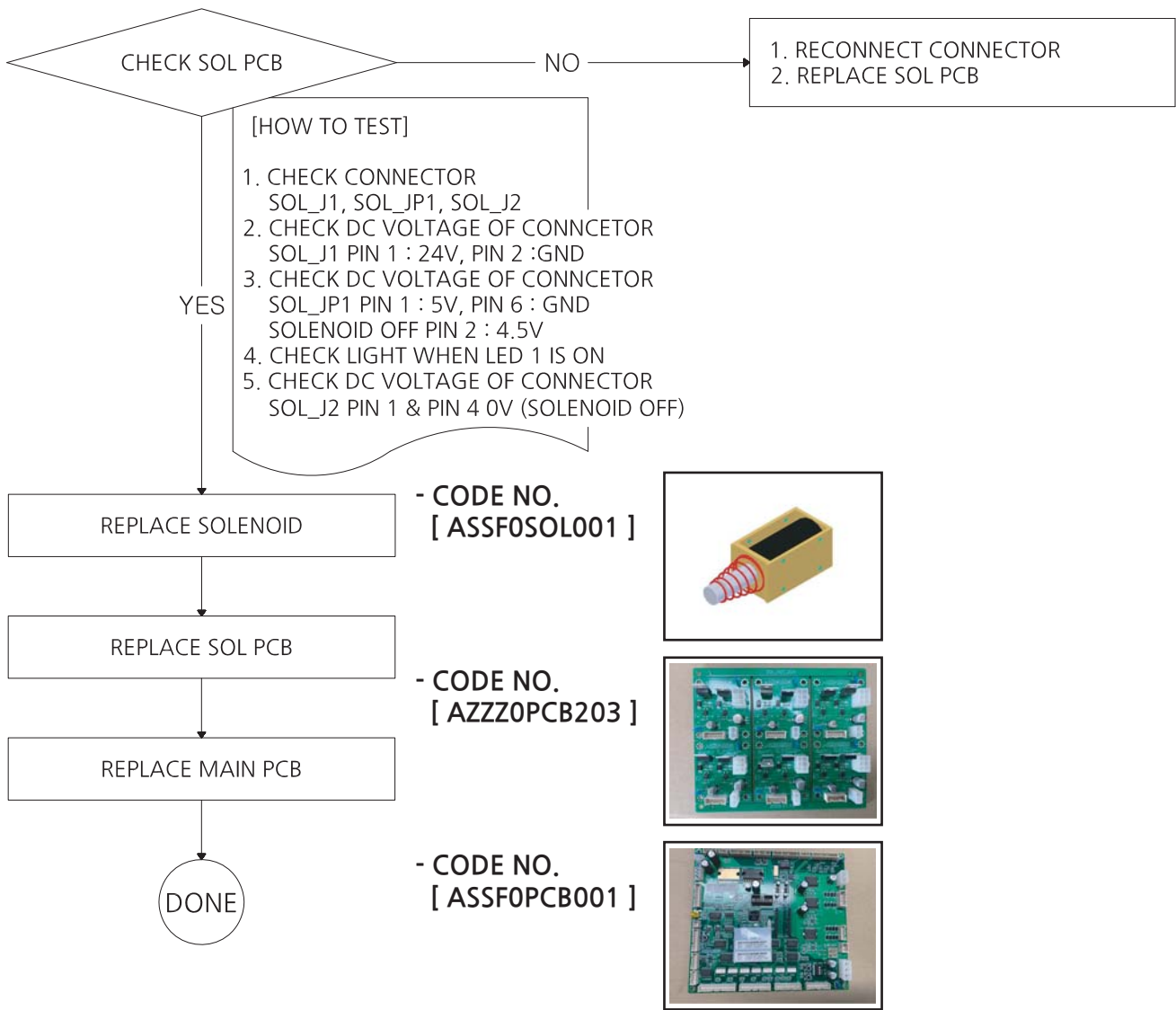

\* General check up : Check the supply voltage and wiring connection properly  
 \* "NO" : Means faulty of the check up result.

## 7. IN CASE OF SOLENOID RIGHT PROBLEM

SOLENOID RIGHT

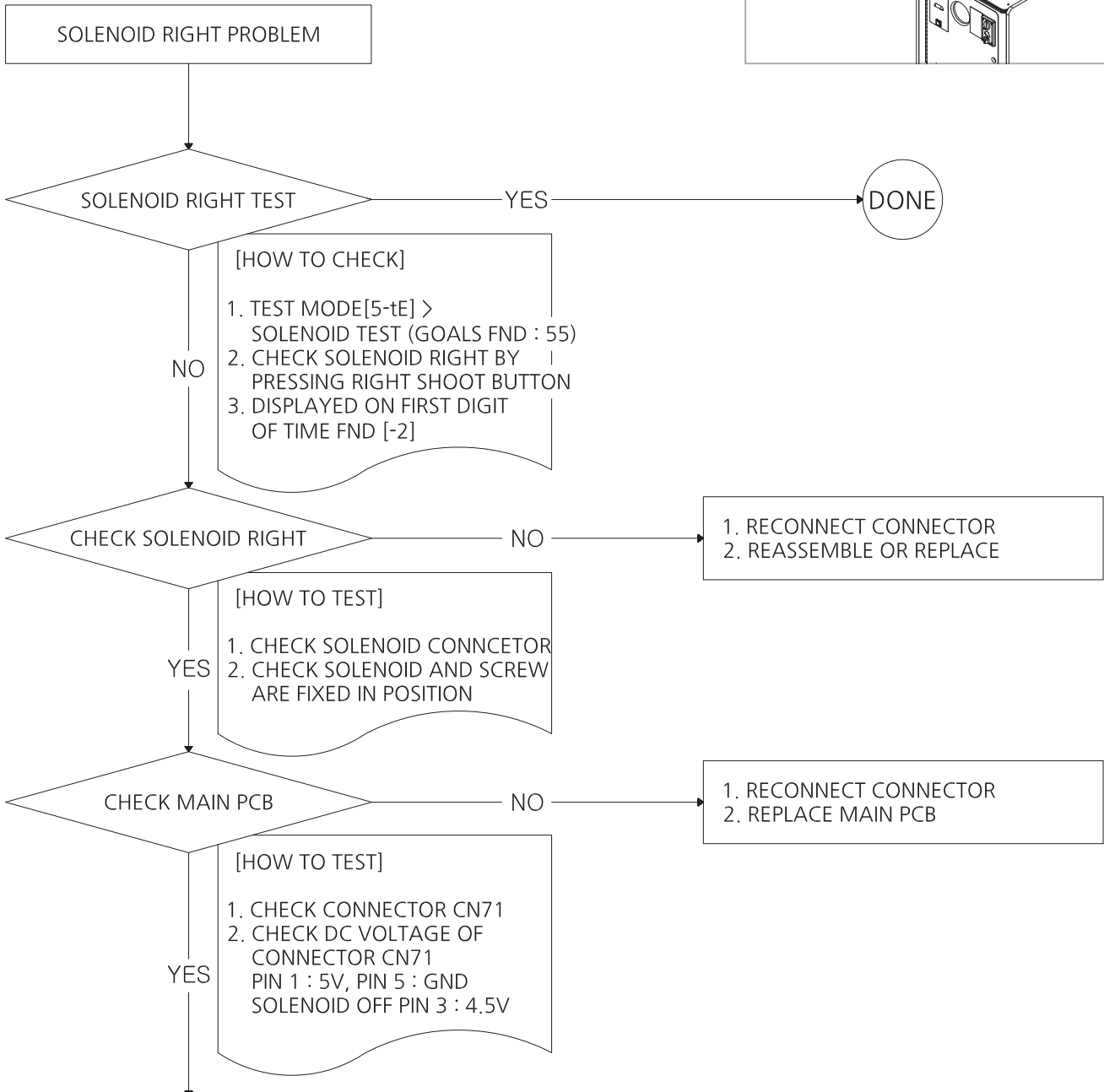
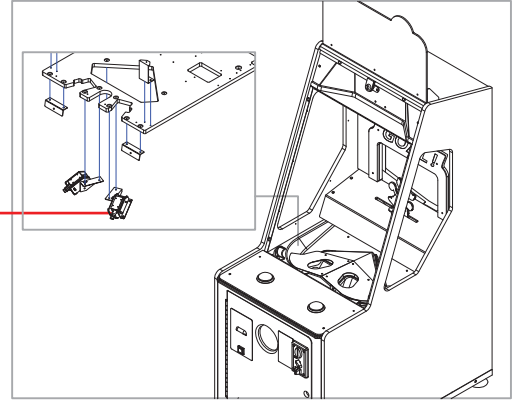

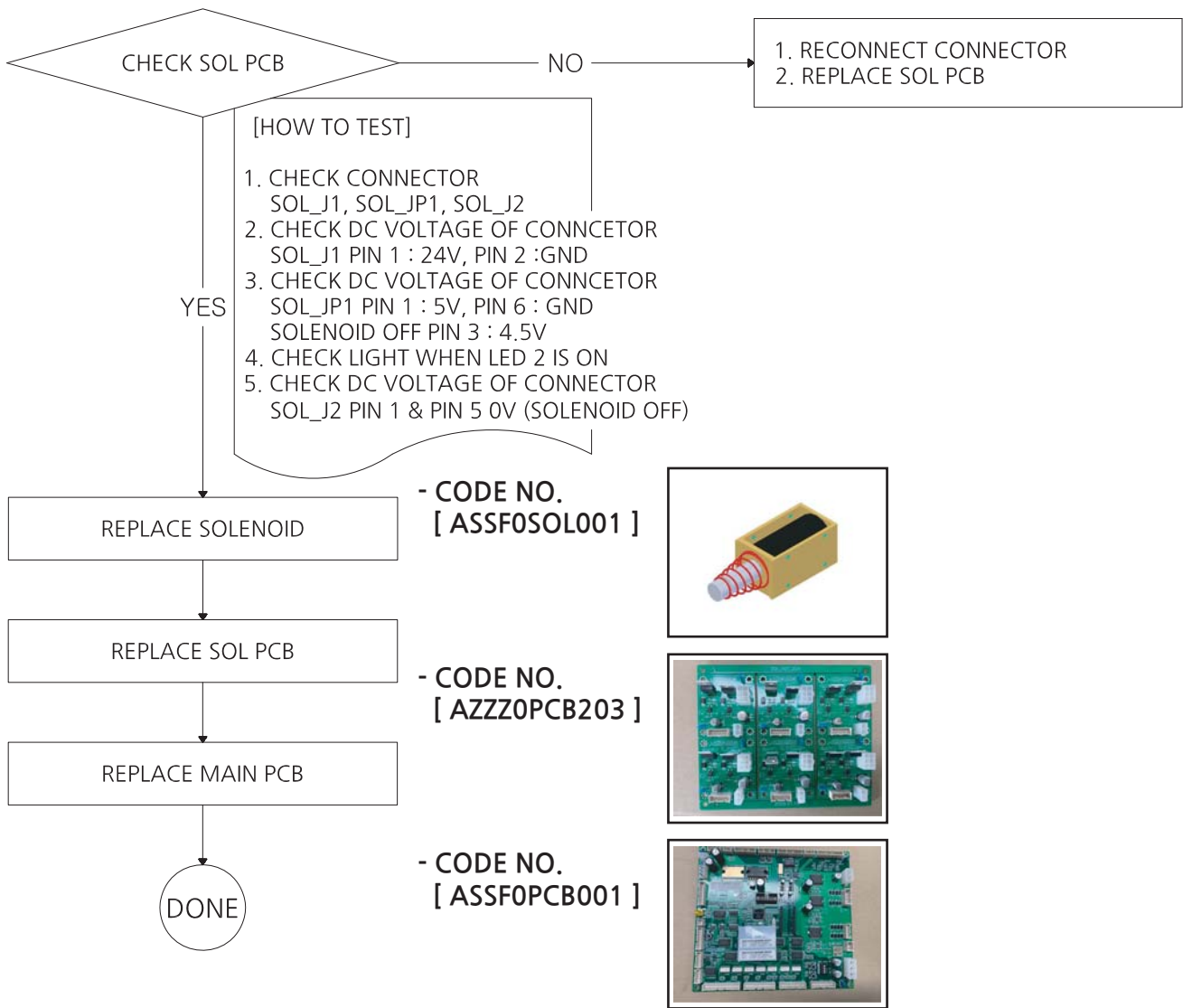

# 4. WARRANTY ITEM & PART PICTURE

- GOALKEEPER MOVING PART

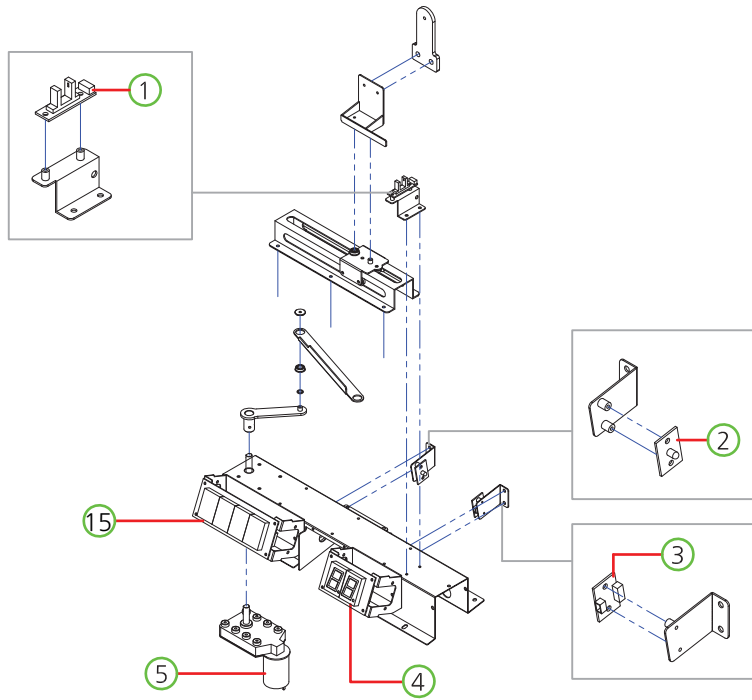

- BALL TRAFFIC JAM PART

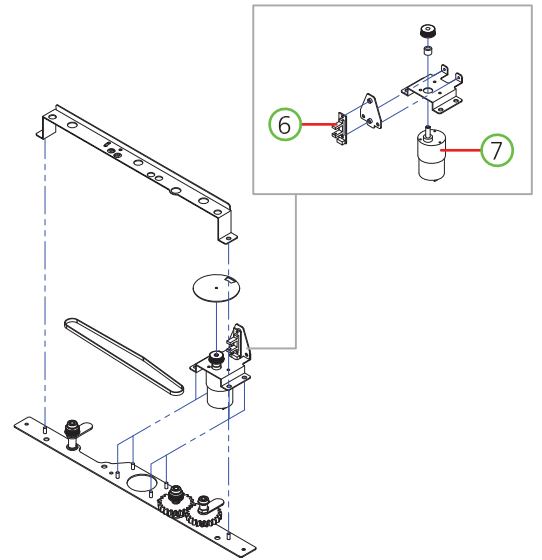

- SOLENOID-1P, 2P PART

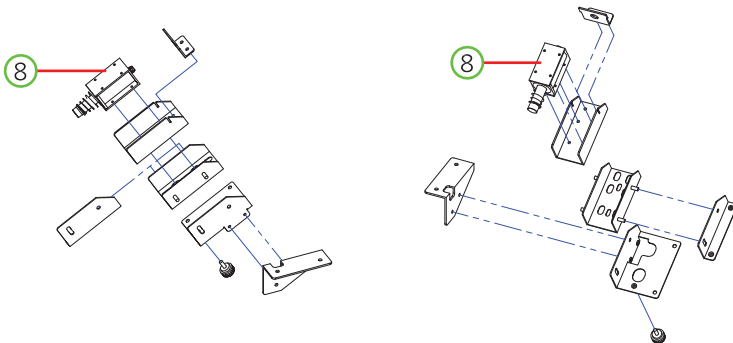

- SETUP PANEL PART

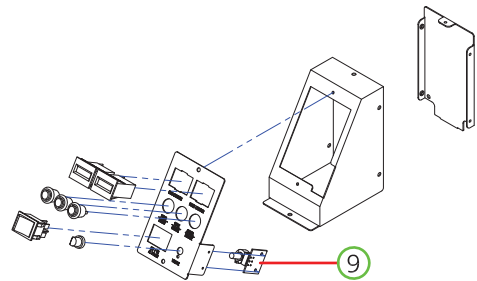

- MAIN BOARD PCB PART

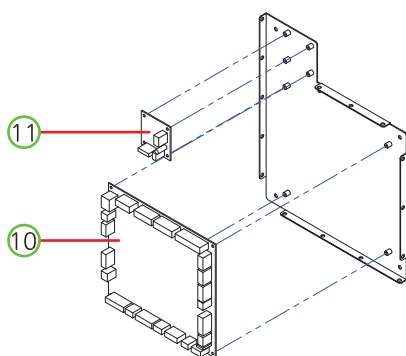



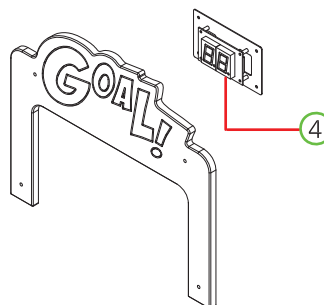

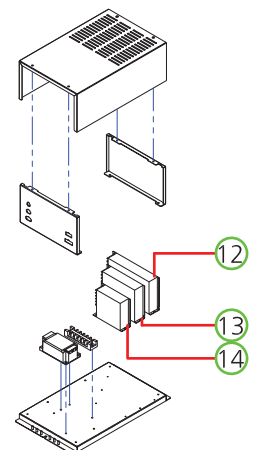

- GOAL POST PART





- SMPS BOX PART



NO.	PIC	PART NAME	SPEC.	QTY	CODE NO.	WARRANTY	
						6 Month	One Year
①	○	PHOTO INT-1 PCB ASS'Y	-	1	AZZZ0PCB103		○
②	○	SENSOR_T PCB ASS'Y	-	1	ASSF0PCB002		○
③	○	SENSOR_R PCB ASS'Y		1	MEIF0PAR014		○
④	○	FND PCB ASS'Y	2941-2(STRAIGHT)	2	AFND0PCB003		○
⑤	○	MOTOR	KGE-3448-050-12V_1/204 F-TYPE	1	MZZZ0MOT072	○	
⑥	○	PHOTO INT-1 PCB ASS'Y	ANGLE TYPE	1	AZZZ0PCB103		○
⑦	○	MOTOR	KGC-0090-3429 50RPM(W/TAP)	1	MZZZ0MOT165	○	
⑧	○	SOLENOID ASS'Y	-	2	ASSF0SOL001	○	
⑨	○	VOLUME PCB ASS'Y	1 VOLUME	1	AHM20PCB016		○
⑩	○	ADSTAR MAIN IO PCB ASS'Y	-	1	ASSF0PCB001		○
⑪	○	SOL FET 2CH PCB ASS'Y	12V_2CH	1	AZZZ0PCB203		○
⑫	○	POWER SMPS	LRS 150F-24	1	MELE0SMP085		○
⑬	○	POWER SMPS	LRS 150F-12	1	MELE0SMP090		○
⑭	○	POWER SMPS	RS 75-5	1	MELE0SMP040		○
⑮	○	FND PCB ASS'Y	2941-4(STRAIGHT)	1	AFND0PCB004		○

1	2	3	4	5	6
					
AZZZ0PCB103	ASSF0PCB002	MEIF0PAR014	AFND0PCB003	MZZZ0MOT072	AZZZ0PCB103

7	8	9	10	11	12
					
MZZZ0MOT165	ASSF0SOL001	AHM20PCB016	ASSF0PCB001	AZZZ0PCB203	MELE0SMP085

13	14	15
		
MELE0SMP090	MELE0SMP040	AFND0PCB004