

SERVICE MANUAL



SOCCER STARS



Ver 1.0



ISSUE DATE: MARCH. 16, 2021



- ▶ Please read the manual carefully and keep it in mind before using this machine.
- ▶ Put this manual within touch of your reference in anytime.

PRECAUTIONS FOR USE

The following safety precautions are given throughout this manual. They must be strictly followed to protect those who install, use or maintain this product as well as to protect players, visitors and property.

For safety reasons.

- The following suggestions should be adhered to:



Disregarding could result in serious injury.



Disregarding could result in injury or product damage.

- The following graphic suggestions describe the types of precautions to be followed.



Indicates a care should be taken.



Forbidden.



Indicates a matter which must be performed.

- **Precautions to be followed:**

Certain procedures require a qualified in-shop maintenance person or industry specialist.

For such instructions, a qualified person must take care of the jobs.

- Otherwise an electric shock, machine trouble or a serious accident may result.
- Replacing the machine parts, inspecting and maintaining the machines and troubleshooting must be assigned only to a qualified in-shop maintenance person or industry specialist. This booklet gives instructions that hazardous jobs in particular must be handled by an industry specialist. Qualified in-shop maintenance person and industry specialist are defined as follows.

Qualified in-shop maintenance person

- A service staff shall have experience in operations of game machines. The staff shall be responsible for assembly, installation, inspection and maintenance of the machine.

Industry specialist

- An industry specialist must be engaged in designing, manufacturing, inspecting and servicing amusement machines. He or she must have an education in electrical, electronic and mechanical engineering and routinely maintain and repair amusement machines.

PRECAUTIONS FOR USE

WARNING

Be sure to consult an industry specialist when setting up, moving or transporting this product.

- This product should not be set up, moved or transported by any one other than an industry specialist.
- When installing this product, set the 4 leg levelers evenly on the floor and make sure that the product is installed stably in a horizontal position. Unstable installation may result in injury or accident.
- When installing this product, do not apply undue force on movable parts. Otherwise, injury and accident may result, or the product may be damaged.

The machine for indoor usage only does not install outside.



Do not set the game machine up near emergency exits.



Protect the game machine from:

- Rain or moisture.
- Direct sunlight.
- Direct heat from air-conditioning and heating equipment, etc..
- Hazardous flammable substances.
- Otherwise an accident or malfunction may result.



Do not place containers holding chemicals or water on or near the game machine.



Do not place objects near the ventilating holes.



Do not bend the power cord by force or place heavy objects on it.



Never plug or unplug the power cord with wet hands.



Never unplug the game machine by pulling the power cord.



CAUTION

Be sure to use indoor wiring within the specified voltage requirements. For extension cord, use the specified rating or more.

Be sure to use the attached power cord.

Never plug more than one cord at a time into the electrical receptacle.



Do not lay the power cord where people walk through.



Be sure to ground this product.



Do not exert excessive force when moving the machine.



For proper ventilation, keep the game machine 100mm(4") away from the walls.

Do not alter the system related dipswitch settings.

PRECAUTIONS FOR USE

WARNING

If there is any abnormality such as smoke, bad smell or abnormal noise being emitted from the machine, immediately turn OFF the main power switch and unplug the power cord from the receptacle to stop operating it. 

- Using the machine in abnormal conditions could result in fire or accidents.

In case of abnormality

1. Turn OFF the main power switch.
2. Unplug the power cord from the receptacle.
3. Contact your nearest dealer.

Do not leave the power cord plugged in improperly or covered with dust. 

- Doing so could result the power cord periodically.

CAUTION

Do not use this product anywhere other than industrial areas. 

- Using in a residential area or an area next to a residential area could affect signal reception of radios, television sets, telephones and etc..
- Do not give shock the surface of glass products.

- Please do not play this game if
 - When you do drinking;
 - When your physical condition is not normal;
 - When you are in pregnancy;
 - When you have on a pulse controller;
 - When you have recently experienced a cramp or fainting away while watching TV.
- Avoid excessive force/shock while playing/moving the game.
- While do games, pay attention to surrounding.

Do not plug or unplug the power cord with wet hands. 

In handling the power cord, follow the instructions below. 

- | | |
|---|--|
| • Do not damage the power cord. | • Do not modify the power cord. |
| • Do not bend the power cord excessively. | • Do not twist the power cord. |
| • Do not heat the power cord. | • Do not pull the power cord. |
| • Do not bind the power cord. | • Do not stand on the power cord. |
| • Do not sandwich the power cord. | • Do not drive a nail into the power cord. |

If the power cord or power plug becomes damaged, stop using the machine immediately and ask your nearest dealer to replace the parts.

*** Electromagnetic wave may cause unexpected noise from speaker.**

PRECAUTIONS FOR USE

⚠ WARNING

Be sure to turn OFF the main power switch and unplug the power cord from the receptacle before inspecting or cleaning the machine.



When replacing parts, be sure to use parts of the correct specifications. Never use parts other than the specified ones.



Opening inside the machine shall be done by machine specialist only as high electric current is being sent inside. For game machine with monitor, a care should be taken while opening its back door. If not, a damage to the inside parts or the monitor may occur.



If the sub power switch of the service panel is turned OFF without turning OFF the main power switch of the power supply unit, some parts in the units remain live. When opening the back door, be sure to turn OFF the main power switch and unplug the power cord from the receptacle.



Strictly refrain from disassembly and repair of parts which are not indicated in this manual, as well as settings and remodeling.



To clean the game machine, wipe it with a soft cloth dampened in a neutral detergent.

- Using thinner or other organic solvent or alcohol may decompose the material.
- Electrical shock or equipment failure could be caused by water entering the inside of the machine.

⚠ CAUTION

Components in the game are sensitive to vibrations and impact. Care should be used when moving and transporting the game machine.



Be sure not to let the machine tip over.

Before moving the machine, be sure to turn OFF the main power switch, unplug the power cord from the receptacle and remove the power cord from the machine.



Before moving take the machine, off the levelers and move it on the casters.

Avoid excessive force while moving the machine.

.....

PRECAUTIONS IN HANDLING

- When setting up, inspecting, maintaining, moving or transporting this product, follow the procedures and instructions set forth in this manual and perform such work safely.
- Do not set up, handle, inspect, maintain, move or transport this product under conditions equivalent to the condition of "WARNING" or "CAUTION" specified in this manual.
- If a new owner is to have this product as a result of transfer, and etc., be sure to give this manual to the new owner.

PRÉCAUTION D'EMPLOI

Les consignes de sécurité suivantes sont données dans ce manuel. Elles doivent être strictement suivies pour protéger ceux qui les installent. Utiliser ou entretenir ce produit pour la sécurité des utilisateurs, des visiteurs et des biens.

Pour des raisons de sécurité.

- **Les suggestions suivantes doivent être respectées:**

ATTENTION

Le non-respect peut entraîner des blessures graves.

PRUDENCE

Le non-respect peut entraîner des blessures ou des dommages au produit.

- **Les suggestions graphiques suivantes décrivent les types de précautions à prendre.**



Indique qu'attention est requise.



Interdit.



Indique que quelque chose doit être effectuée.

- **Les précautions à prendre :**

Certaines procédures exigent une personne de maintenance qualifiée en atelier ou un spécialiste de l'industrie. Pour ces instructions, une personne qualifiée doit prendre soin des travaux.

- Sinon, un choc électrique, un dysfonctionnement de la machine, ou un accident grave peut en résulter.
- Remplacement des pièces de machines, l'inspection et la maintenance des machines, et le dépannage doit être attribué qu'à une personne de maintenance qualifiée en atelier ou spécialiste de l'industrie. Cette brochure donne des instructions que les emplois dangereux, en particulier, doivent être traités par un spécialiste de l'industrie. La personne de maintenance qualifiée en atelier et le spécialiste de l'industrie sont définis comme suit.

La personne de maintenance qualifiée en atelier

- Un personnel de service doit avoir de l'expérience dans les opérations de machines de jeux. Le personnel est responsable pour l'assemblage, l'installation, l'inspection et l'entretien de la machine.

Le spécialiste de l'industrie

- Un spécialiste de l'industrie doit être engagé dans la conception, la fabrication, l'inspection et l'entretien des appareils d'amusement.
Il ou elle doit avoir une formation en génie électrique, électronique et mécanique, et de maintenir régulièrement et de réparer les appareils d'amusement.

PRÉCAUTION D'EMPLOI

ATTENTION

Si il y a une anomalie comme fumée, mauvaise odeur ou bruit anormal émis par la machine,  couper immédiatement l'interrupteur principal et débranchez le câble d'alimentation de la prise pour arrêter son fonctionnement.

- L'utilisation de l'appareil dans des conditions anormales peut provoquer un incendie ou un accident.

En cas d'anomalie

1. Mettez l'interrupteur principal sur ARRÊT.
2. Débranchez le câble d'alimentation de la prise.
3. Contactez votre revendeur le plus proche.

Ne pas brancher le câble d'alimentation incorrectement ou le laisser être recouvert de poussière. 

Cela pourrait nuire le câble d'alimentation.

PRUDENCE

Ne pas utiliser ce produit ailleurs que dans les zones industrielles. 

- L'utiliser dans une zone résidentielle ou d'une zone à côté d'un quartier résidentiel pourrait nuire à la réception des radios, téléviseurs, téléphones, etc.
- Ne donnez pas de choc à la surface d'un produit en verre.

- S'il vous plaît ne pas jouer à ce jeu.
 - Quand vous buvez;
 - Lorsque votre condition physique n'est pas normale;
 - Lorsque vous êtes dans une période de grossesse;
 - Lorsque vous avez un contrôleur d'impulsion;
 - Lorsque vous avez récemment subi une crampe ou évanouissement en regardant la télévision.
- Évitez une force excessive / un choc pendant la lecture / de déplacer le jeu.
- Quand vous jouez les jeux, faites attention aux alentours.

Ne pas brancher ou débrancher le câble d'alimentation avec les mains mouillées. 

Dans la manipulation du câble d'alimentation, suivez les instructions ci-dessous. 

- | | |
|--|---|
| • Ne pas endommager le câble d'alimentation. | • Ne pas modifier le câble d'alimentation. |
| • Ne pas plier le câble d'alimentation de manière excessive. | • Ne tordez pas le câble d'alimentation. |
| • Ne pas chauffer le câble d'alimentation. | • Ne tirez pas sur le câble d'alimentation. |
| • Ne pas lier le câble d'alimentation. | • Ne montez pas sur le câble d'alimentation. |
| • Ne pas prendre en sandwich le câble d'alimentation. | • Ne pas mettre un clou dans le câble d'alimentation. |

Si la fiche du câble d'alimentation ou est endommagé, cessez immédiatement d'utiliser la machine et demandez à votre revendeur le plus proche de remplacer les pièces.

PRÉCAUTION D'EMPLOI

ATTENTION

Assurez-vous de consulter un spécialiste de l'industrie lors de la mise en place, du déplacement ou le transport de ce produit.

- Ce produit ne doit pas être mis en place, déplacé ou transporté par une quelconque autre qu'un spécialiste de l'industrie.
- Lors de l'installation de ce produit, installez 4 niveleurs de pieds uniformément sur le sol et assurez-vous que le produit est installé de façon stable dans une position horizontale. Une installation instable peut entraîner des blessures ou un accident.
- Lors de l'installation de ce produit, ne pas appliquer une force excessive sur les pièces mobiles. Sinon, des blessures et des accidents peuvent y résulter, ou le produit peut être endommagé.

La machine pour une utilisation en intérieur uniquement, ne pas installer à l'extérieur.



N'installez pas la machine de jeu près des issues de secours.



Protéger la machine de jeu de:



- L'humidité ou la pluie.
- La lumière directe du soleil.
- La chaleur directe de la climatisation et du chauffage, etc...
- Des substances inflammables dangereuses.
- Sinon, un accident ou un dysfonctionnement.

Ne pas placer les récipients contenant des produits chimiques ou de l'eau sur ou près de la machine de jeu.



Ne placez pas d'objets à proximité des orifices de ventilation.



Ne pas plier le cordon d'alimentation par la force ou de placer des objets lourds au-dessus.



Ne jamais brancher ou débrancher le cordon d'alimentation avec les mains mouillées.



Ne jamais débrancher la machine de jeu en tirant le câble d'alimentation.



PRUDENCE

Veillez à utiliser le câblage intérieur selon les exigences de tension spécifiées. Pour une rallonge, utilisez la notation spécifiée ou plus.

Veillez à utiliser le cordon d'alimentation fourni.

Ne jamais brancher plus d'un cordon à la fois dans la prise électrique.



Ne pas poser le cordon d'alimentation où les gens marchent à travers.



Soyez sûr de mettre à la terre ce produit.



Ne pas exercer une force excessive lors du déplacement de la machine.



Pour une ventilation correcte, garder la machine de jeu 100mm (4 ") loin des murs.

Ne pas modifier les réglages des commutateurs DIP liées au système.

PRÉCAUTION D'EMPLOI

ATTENTION

Veillez à éteindre l'interrupteur d'alimentation principale et débranchez le cordon d'alimentation de la prise avant d'inspecter ou de nettoyer la machine. 

Lors du remplacement des pièces, veillez à utiliser une partie des spécifications correctes. Ne jamais utiliser de pièces autres que celles spécifiées. 

L'ouverture à l'intérieur de la machine doit être effectuée par le spécialiste de la machine seulement, comme le courant électrique élevé est transmis à l'intérieur. Pour la machine de jeu avec le moniteur, un soin doit être pris lors de l'ouverture de sa porte arrière. Si non, une détérioration des pièces à l'intérieur ou à l'écran peut se produire. 

Si l'interrupteur secondaire du panneau de service est éteint sans éteindre le commutateur d'alimentation principale de l'unité d'alimentation, certaines parties dans les unités restent sous tension. Lors de l'ouverture de la porte arrière, veillez à éteindre l'interrupteur d'alimentation principale et débranchez le cordon d'alimentation de la prise. 

Il est strictement conseiller de s'abstenir de démonter et de réparer des pièces qui ne sont pas indiqués dans ce manuel, ainsi que les paramètres et le remodelage. 

Pour nettoyer la machine de jeu, l'essuyer avec un chiffon doux imbibé avec un détergent neutre.

- L'utilisation plus mince d'un autre solvant organique ou de l'alcool peut décomposer le matériel.
- Un choc électrique ou une défaillance de l'équipement pourraient être causés par la pénétration de l'eau à l'intérieur de la machine.

PRUDENCE

Les composants de la machine de jeu sont sensibles aux vibrations et aux chocs. Il faut faire attention lors du déplacement et le transport de la machine de jeu. 

Veillez à ne pas laisser la machine se renverser.

Avant de déplacer la machine, veillez à éteindre l'interrupteur d'alimentation principale, débranchez le cordon d'alimentation de la prise et débranchez le cordon d'alimentation de la machine. 

Avant de déplacer la machine, la mettre hors des niveleurs et le déplacer sur les roulettes.

Éviter une force excessive lors du déplacement de la machine.

.....

PRÉCAUTIONS LORS DU MANIEMENT

- Lors de la mise en place, l'inspection, l'entretien, déplacement ou le transport de ce produit, suivez les procédures et les instructions énoncées dans ce manuel et effectuer ce travail en toute sécurité.
- Ne pas mettre en place, manipuler, inspecter, entretenir, déplacer ou transporter ce produit dans des conditions équivalentes à l'état de "ATTENTION" ou "PRUDENCE" spécifiée dans ce manuel.
- Si un nouveau propriétaire obtient ce produit à la suite d'un transfert, etc., soyez sûr de donner ce manuel au nouveau propriétaire.

CONTENTS

1. SPECIFICATION AND DIMENSION	P03
1-1. DIMENSION	P03
1-2. SPECIFICATION	P04
1-3. NAME OF PARTS	P04
1-4. STICKER LOCATION	P05
1-5. COMPONENTS	P06
2. INSTALLATION	P07
2-1. INSTALLATION SPACE	P07
2-2. HOW TO INSTALL	P08
3. SETUP SETTINGS	P09
3-1. MACHINE SETUP	P09
3-2. SETUP MODE	P10
3-3. CLEAR MODE	P13
3-4. TEST MODE	P16
3-5. ERROR CODE	P20
4. TROUBLESHOOTING	P23
4-1. IN CASE OF GOALKEEPER MOTOR PROBLEM [Er. 31]	P23
4-2. IN CASE OF GOALKEEPER SENSOR PROBLEM [Er. 31]	P24
4-3. IN CASE OF BALL MOUNTING MOTOR PROBLEM [Er. 41]	P26
4-4. IN CASE OF BALL MOUNTING MOTOR SENSOR PROBLEM [Er. 41]	P27
4-5. IN CASE OF GOAL IN HOLE SENSOR PROBLEM [Er. 71]	P29
4-6. IN CASE OF SOLENOID LEFT PROBLEM	P31
4-7. IN CASE OF SOLENOID RIGHT PROBLEM	P33

5. EXPLODED VIEW	P35
5-1. MAIN CABINET PART	P35
5-2. BILLBOARD PART	P36
5-3. PLAYFIELD PART	P37
5-4. GOALKEEPER MOVING PART	P38
5-5. BALL TRAFFIC JAM PART	P39
5-6. SOLENOID-1P, 2P PART	P40
5-7. PLAYFIELD BOTTOM LED FIX BKT PART	P40
5-8. GOALKEEPER PART	P40
5-9. BALL GROUND MOLD PART	P41
5-10. GOAL POST PART	P42
5-11. BILLBOARD LED PART	P42
5-12. BUTTON ACRYL PART	P43
5-13. SETUP PANEL PART	P43
5-14. FRONT DOOR PART	P44
5-15. FRONT GLASS DOOR PART	P44
5-16. MAIN BOARD PCB PART	P45
5-17. AC INPUT PART	P45
5-18. SMPS BOX PART	P45
5-19. MAIN CABINET REAR DOOR PART	P46
6. WARRANTY ITEM & PART PICTURE	P47
7. BLOCK DIAGRAM	P49

1. SPECIFICATION AND DIMENSION

1-1. DIMENSION

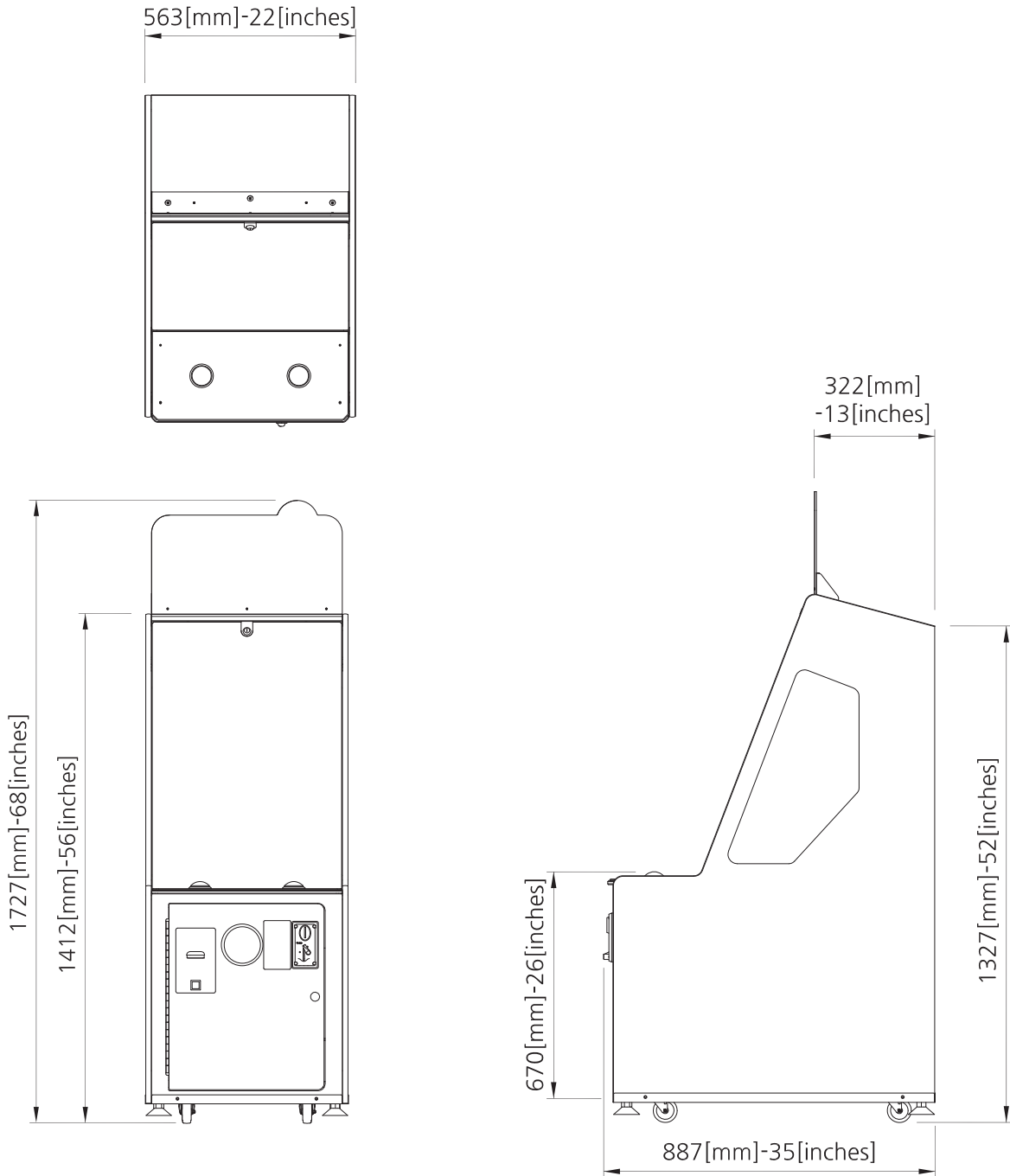

1-2. SPECIFICATION

DIMENSION (W x D x H)	563 x 887 x 1727 (mm)
PACKING DIMENSION (W x D x H)	765 x 960 x 1630 (mm)
WEIGHT (kg)	90 kg [WEIGHT INCLUDING : 100 kg] PACKAGING
VOLTAGE	AC 120V
FREQUENCY RANGE	60Hz
CONSUMPTION	90W

* The 120V voltage specification is for the Americas only, and the 230V (50/60Hz) voltage specifications are for other countries. 3

1-3. NAME OF PARTS

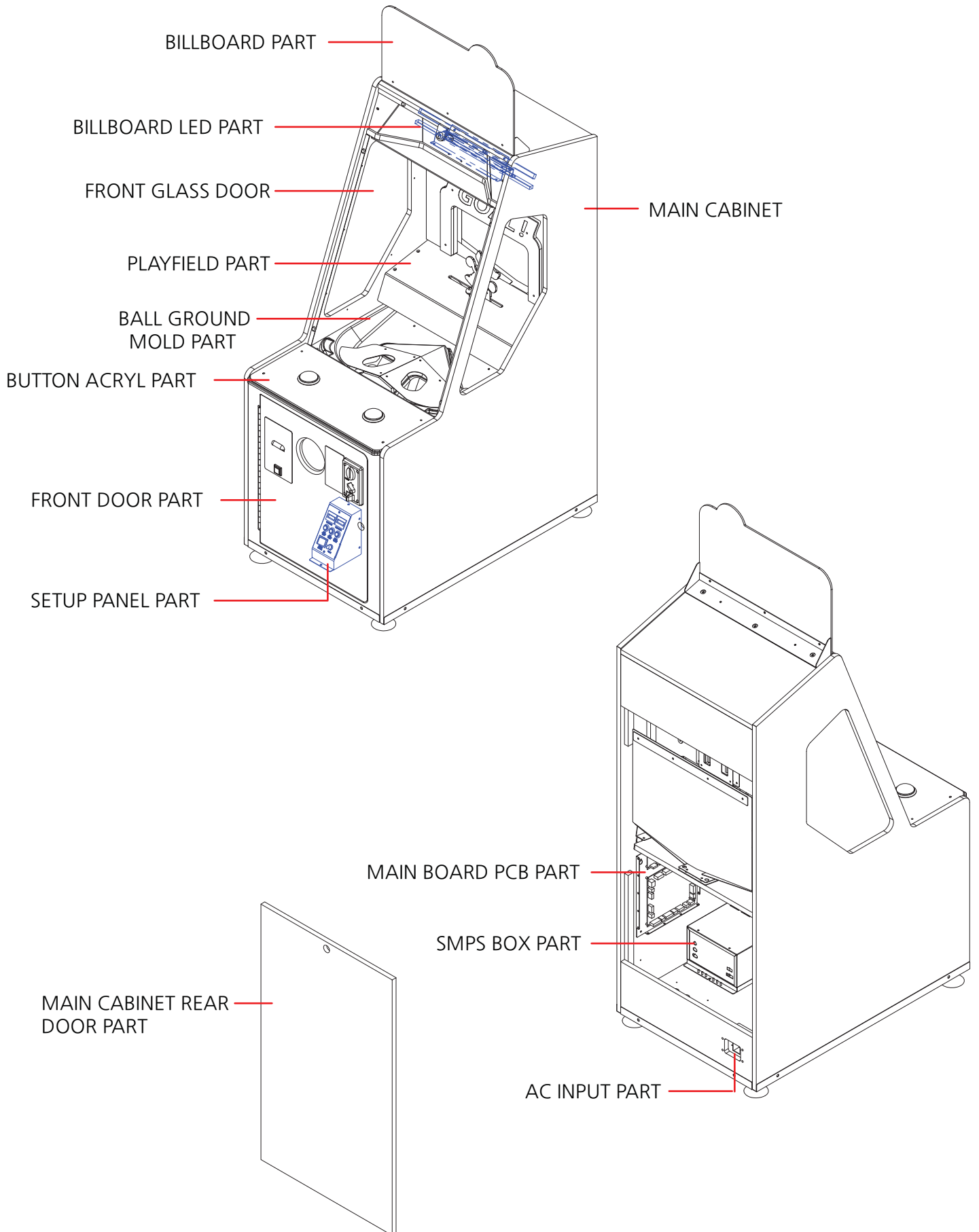

1-4. STICKER LOCATION

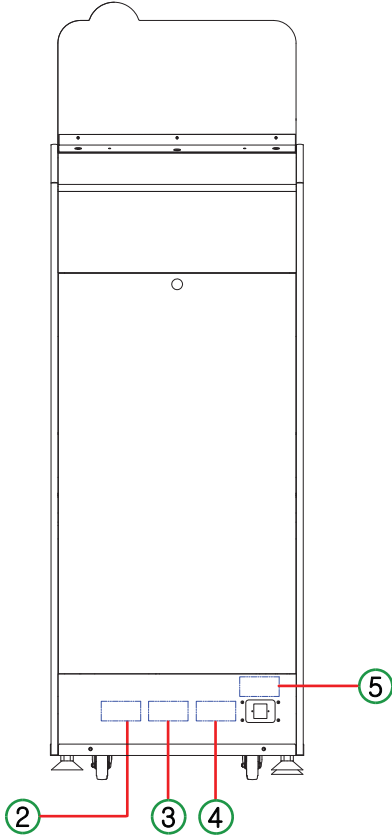
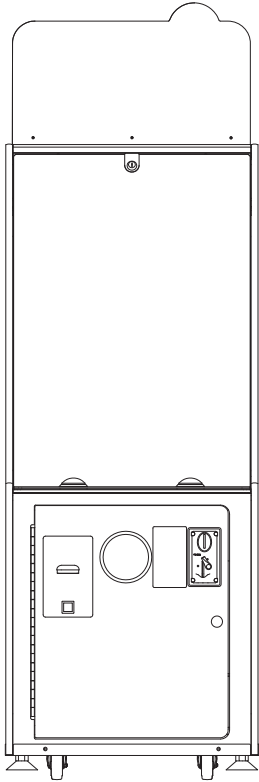



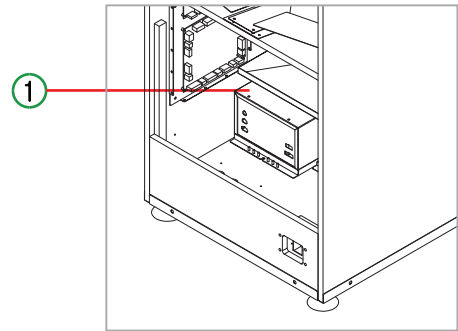



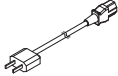

- SMPS BOX COVER



1	<p>⚠ WARNING/ATTENTION</p> <p>Except service personnel, please never open the product as there is a risk of electric shock.</p> <p>Il y a un risque d'électrocution, n'ouvrez pas le produit excepté le responsable, s'il vous plaît.</p>	2		3	<p>WARNING ROCKING, SHAKING, OR TIPPING MAY CAUSE INJURY OR DEATH! This unit must be fastened securely to the wall, floor or adjacent object in compliance with the installation instructions.</p> <p>ATTENTION AGITER, SECOUER OU BASCULER PEUT CAUSER DES BLESSURES OU ENTRAINER LA MORT! Cetle unité doit être fixée au mur, au plancher ou à un objet à proximité conformément aux instructions d'installation.</p>
4	<p>Certification Label</p>	5	<p>⚠ CAUTION/PRUDENCE</p> <p>"For continuous protection against risk of fire, replace only with the same type 10A-250V fuse"</p> <p>"Pour une protection continue contre les risques d'incendie, remplacer un fusible avec seulement le même type 10A-250V"</p>		

1-5. COMPONENTS

NO.	PART NAME	SPEC.		QTY
1	AC POWER CORD	-		1
2	KEY	6001, 7001		2 EACH
3	BOLT	M4x10L		3
4	WRENCH	2.5, 3 mm		1 EACH
5	BALL	-		6
6	STATIC OFF SPRAY	-		1
7	COIN SELECTOR BLANK BKT			1
8	MANUAL			1
9	TROUBLESHOOTING MANUAL			1

2. INSTALLATION

2-1. INSTALLATION SPACE

- Need to have installation place.
Maintenance zone & Play zone should have at least 1000mm x 1500mm each.

***IMPORTANT**

- Once you set up the machine with required game-play area, when installing this product, set the 4 leg levelers evenly on the floor and make sure that the product is installed stably in a horizontal position.

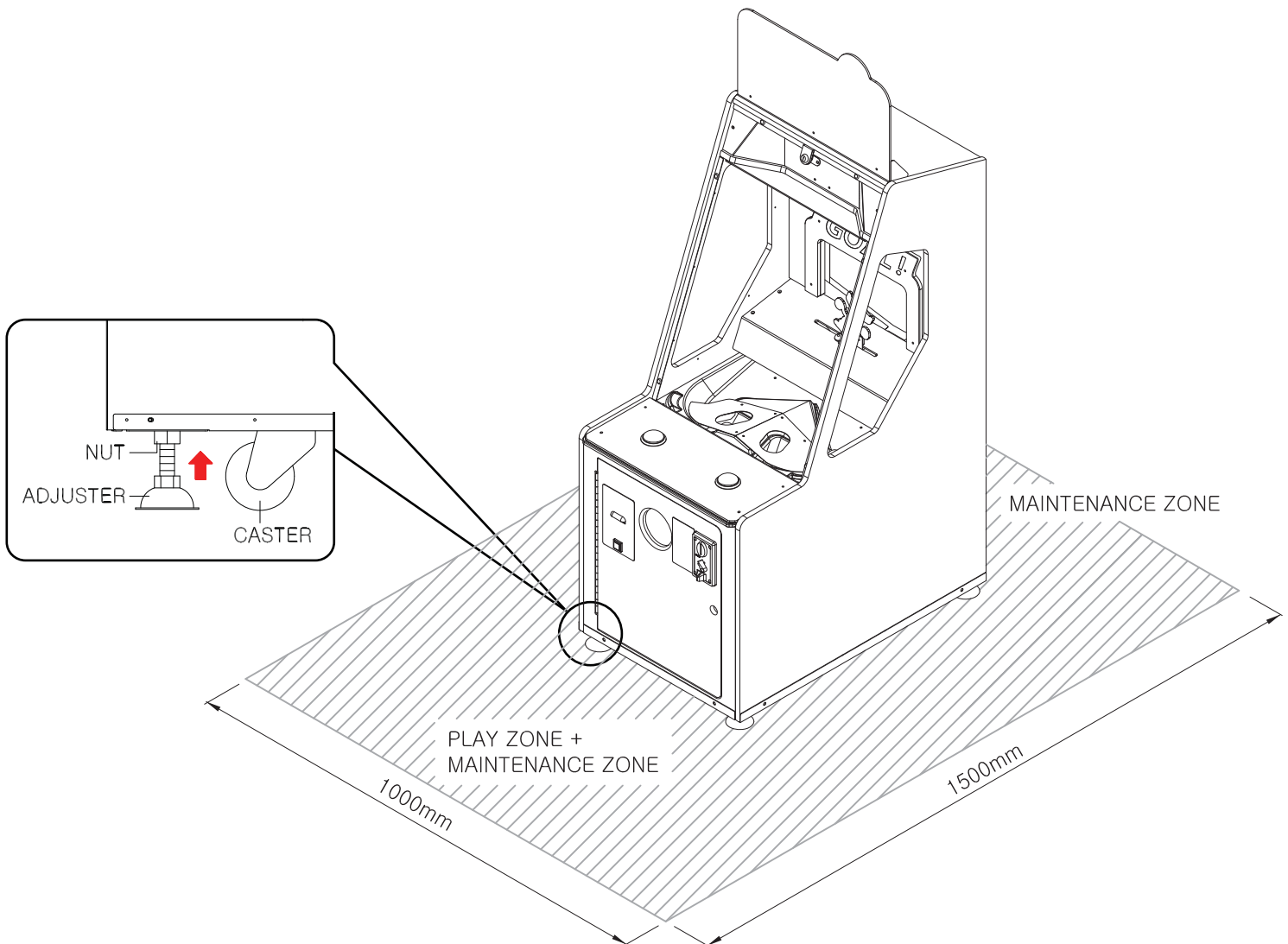

2-2. HOW TO INSTALL

1

* BILLBOARD ASS'Y

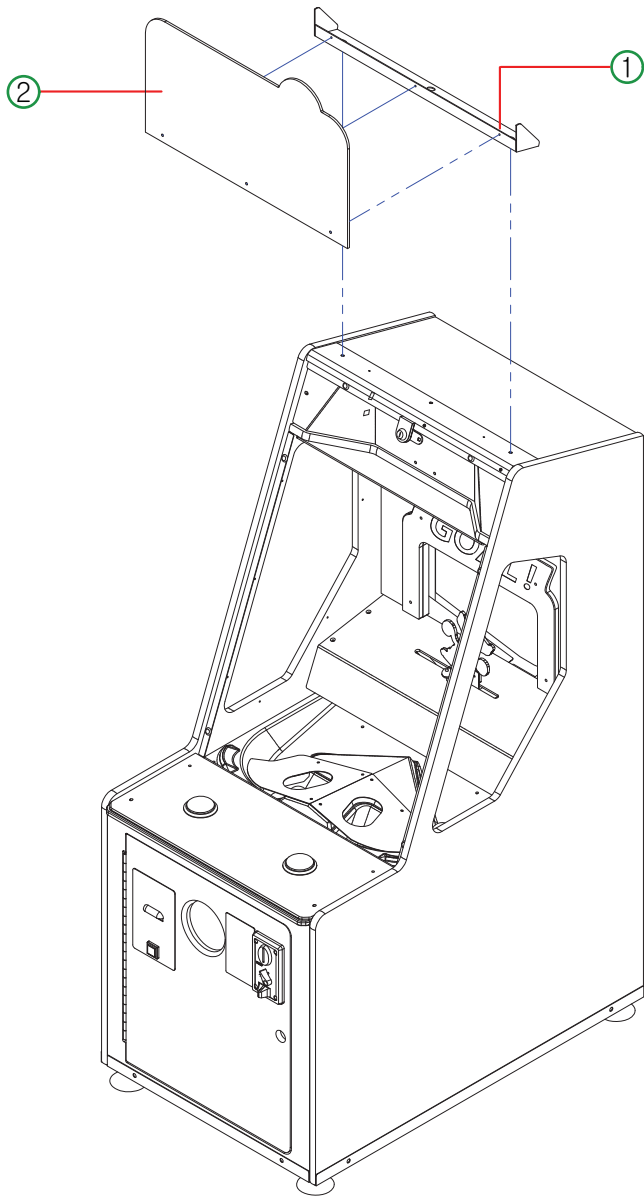

- After assembling ① TITLE ACRYL BKT + ② BILLBOARD FORMAX connect connector using [M4 bolts, 5pcs]

2

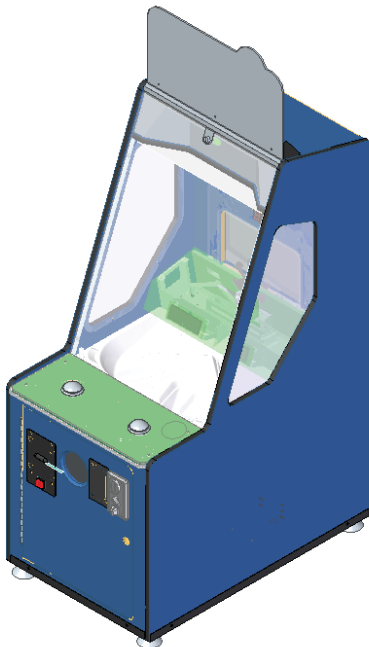



- Please complete assembling as shown in the picture.





3. SETUP SETTING







3-1. MACHINE SETUP

1. SETUP BUTTON LAYOUT

















 <p>MENU/SELECT MOVE/CHANGE CANCEL/SERVICE</p>	<p>1) MENU/SELECT: SETUP MENU / SELECT 2) MOVE/CHANGE: MENU MOVE / VALUE CHANGE 3) CANCEL/SERVICE: CANCEL / SERVICE BUTTON (IN CASE OF ERROR, ERROR CLEAR BUTTON)</p>
<p>FND DISPLAY FOR MENU ITEMS AT SET UP IS DISPLAYED AT TICKETS FND AND TIME/CREDIT(s) FND</p> 	

















[OPERATING OPTIONS]







OPERATING OPTIONS			
※HOW TO OPERATE BUTTONS			
1	2	3	4
			
MENU/SELECT	MOVE/CHANGE	MENU/SELECT	CANCEL/SERVICE
ENTER SETUP MODE	MENU ITEM MOVE	ITEM SELECT	CANCEL/EXIT

MENU ITEMS	FND DISPLAY	DESCRIPTIONS
1.PROGRAM SETTINGS	TICKETS TIME 	SETUP MODE (SETTING ITEMS RELATED WITH PROGRESS OF GAME SUCH AS CREDIT/COIN, GAME TIME AND ETC)
2.CLEAR MODE	TICKETS TIME 	DELETE MODE (DELETE ITEMS RELATED WITH CREDIT, PRIZE OUT AND GAME DATA)
3.BOOKKEEPING	TICKETS TIME 	DISPLAY OF GAME DATA (PAYIN, PAYOUT)
4.FACTORY SETTING	TICKETS TIME 	INITIALIZING TO FACTORY SETTING
5.TEST MODE	TICKETS TIME 	OPERATION TEST
6.EXIT (Out)	TICKETS TIME 	EXIT TO OPERATION OPTIONS











3-2. SETUP MODE

PROGRAM SETTINGS					
※ HOW TO MANIPULATE SETTING BUTTONS					
1	2	3	4	5	6
					
MENU/SELECT	MOVE/CHANGE	MENU/SELECT	MOVE/CHANGE	MENU/SELECT	MOVE/CHANGE
ENTER SETUP MODE	MOVE TO MENU ITEMS	SELECT ITEMS TO CHANGE (FLICKERING)	SETTING VALUE CHANGE	SELECT (FLICKERING STOP)	SAVE EXIT MOVE
7	8	9	CANCEL / SERVICE		
					
MENU/SELECT	MOVE/CHANGE	MENU/SELECT	CANCEL/SERVICE		
EXECUTION	SELECT [ye] BETWEEN [ye] AND [no]	SELECT	SELECT CANCEL OR EXIT		
SETTING ITEMS	FND DISPLAY	DESCRIPTION		RANGE	DEFAULT
11. CREDIT(S) / COIN	TICKETS  TIME 	SETTING THE RATIO CREDIT/COIN SETTING REQUIRED COIN INPUT TO INCREASE CREDIT(S) "Fr" : Free Game "11" : 1 Coin Input 1 Credit Increase "12" : 2 Coins Input 1 Credit Increase ~ "15" : 5 Coins Input 1 Credit Increase "21" : 1 Coin Input 2 Credits Increase ~ "51" : 1 Coin Input 5 Credits Increase		"Fr", 11, 12, 13, 14, 15, 21, 31,41, 51	11
12. CREDIT(S) / BILL	TICKETS  TIME 	SETTING THE RATIO CREDIT/BILL INCREASE OF CREDIT(S) RESPONDING TO BILL SIGNAL INPUT INCREASE VALUE OF CREDIT(S) RESPONDING TO BILL SIGNAL INPUT 1 : 1 Credit increases responding to 1 Bill Signal 2 : 2 Credits increase responding to 1 Bill Signal ~ 9 : 9 Credits increase responding to 1 Bill Signal 10 : 10 Credits increase responding to 1 Bill Signal		1 ~ 10 (INCREASES BY 1)	1
13. PLAY TIME	TICKETS  TIME 	LIMIT TIME FOR GAME PLAY 15 ~ 90 : GAME ENDS WHEN TIME REDUCES TO "0" SECOND FROM SETTING TIME		15 ~ 90 (BY SECOND) (INCREASES BY 5)	30









14. TICKET / GOAL	TICKETS  TIME 	TICKET PER GOAL SETTING “51” : 5 TICKETS PER 1 GOAL “31” : 3 TICKETS PER 1 GOAL “21” : 2 TICKETS PER 1 GOAL “11” : 1 TICKETS PER 1 GOAL “12” : 1 TICKETS PER 2 GOALS “13” : 1 TICKETS PER 3 GOALS ~ “10” : 1 TICKETS PER 10 GOALS “no” : NO TICKET	51, 31, 21, 11, 12, 13, 14, 15, 16, 17, 18, 19, 110, no	11
15. SUPER BONUS GOAL SCORE	TICKETS  TIME 	GOALS TO WIN SUPER BONUS	10 ~ 50 (INCREASED BY 1)	25
16. SUPER BONUS VALUE	TICKETS  TIME 	DEFAULT VALUE OF SUPER BONUS	100 ~ 3000 (INCREASES BY 50)	500
17. SUPER BONUS LIMIT	TICKETS  TIME 	MAXIMUM VALUE OF SUPER BONUS (WHEN YOU SET SUPER BONUS INCREMENT)	100 ~ 5000 (INCREASES BY 50)	1000
18. SUPER BONUS INCREMENT	TICKETS  TIME 	NUMBER OF INCREMENT TICKETS TO SUPER BONUS PER GAME	10 ~ 30 (INCREASES BY 1)	0
19. DIFFICULTY	TICKETS  TIME 	CONTROL OF DIFFICULTY LEVEL (MOVEMENT OF GOALKEEPER) 01: CONTIOUS MOVEMENT WITHOUT STOP 02: GOALKEEPER MOVES AFTER PAUSING ONE SECOND AT LEFT OR RIGHT END	“01”, “02”	“01”
20. ATTRACT VOLUME	TICKETS  TIME 	USE OF DEMO SOUND AND VOLUME SETTING “00” : NO DEMO SOUND 10 ~ 99 : SOUND VOLUME % RATIO(99 IS TO TREATED AS 100%)	“0”, 10 ~ 99 (INCREASED BY 10)	60
21. MERCY TICKET	TICKETS  TIME 	MERCY TICKET 0~15	0 ~ 15 (INCREASED BY 1)	0

22. TICKET / SCORE	TICKETS  TIME 	TICKET PER SCORE SETTING "no" : NO TICKET "11" : 1 TICKET PER 1 SCORE "12" : 1 TICKET PER 2 SCORE	00, 11, 12	11
SAVE EXIT	TICKETS  TIME 	SAVE AND EXIT (TO PREVIOUS MENU)	PRESS SELECT BUTTON AND EXECUTE BY MOVING CURSOR TO [yes] or [no]	
EXIT (out)	TICKETS  TIME 	EXIT TO PREVIOUS MENU		









※SAVE AND EXIT : HOW TO OPERATE [yes] or [no] SELECT BUTTON

1	2	3	4
 MENU/SELECT	 MOVE/CHANGE	 MENU/SELECT	
SELECT ITEM	CHECK FLICKERING [ye] ITEM		CHECK [ye] SELECT
TICKETS TIME 	TICKETS TIME  TICKETS TIME 	TICKETS TIME  TICKETS TIME 	TICKETS TIME  TICKETS TIME 

3-3. CLEAR MODE

2. CLEAR MODE			
- ENTER SETUP MODE(MENU/SELECT BUTTON) -> 2-CL (MOVE/CHANGE BUTTON) -> ENTER CLEAR MODE(MENU/SELECT BUTTON) - DELETE REMAINING CREDIT(S), TICKET, GAME DATA AND BOOKKEEPING			
SETTING ITEM	FND DISPLAY	DESCRIPTION	EXECUTION
21. CLEAR CREDIT	TICKETS  TIME 	DELETE REMAINING CREDIT(S)	PRESS SELECT BUTTON AND EXECUTE BY MOVING CURSOR TO [ye] or [no]
22. CLEAR TICKET	TICKETS  TIME 	DELETE REMAINING TICKETS	
23. CLEAR DATA	TICKETS  TIME 	DELETE ALL CREDIT(s), GAME DATA, BOOKKEEPING	
EXIT (out)	TICKETS  TIME 	EXIT (TO PREVIOUS MENU)	

※CLEAR MODE HOW TO OPERATE [ye] or [no] and SELECT

1	2	3	4
			
MENU/SELECT	MOVE/CHANGE		MENU/SELECT
SELECT ITEM	CHECK FLICKERING [ye] ITEM		CHECK [ye] SELECT [OK] FLICKERING
	TICKETS TIME  TICKETS TIME 	TICKETS TIME  TICKETS TIME 	TICKETS TIME  TICKETS TIME 



3. BOOKKEEPING









- ENTER SETUP MODE(MENU/SELECT BUTTON) -> **3-60** (MOVE/CHANGE BUTTON) -> ENTER CLEAR MODE(MENU/SELECT BUTTON)
- CHECK GAME PLAY COUNT, COIN & BILL IN

SETTING ITEM	FND DISPLAY	DESCRIPTION	EXECUTION
31. GAME PLAY	TICKETS TIME 	GAME PLAY COUNT	MOVE TO PREVIOUS MENU BY PRESSING SELECT BUTTON
32. AVERAGE	TICKETS TIME 	AVERAGE DISPENSED TICKETS	
33. TICKET OUT	TICKETS TIME 	TOTAL DISPENSED TICKETS	
34. PAY IN	TICKETS TIME 	COIN & BILL INPUT COUNT (Free Game &Service: NOT INCLUDED)	
35. CREDITS	TICKETS TIME 	TOTAL CREDIT	
36. SERVICE	TICKETS TIME 	SERVICE CREDIT COUNTS	
EXIT (Out)	TICKETS TIME 	EXIT (TO PREVIOUS MENU)	

4. FACTORY SETTING

- ENTER SETUP MODE(MENU/SELECT BUTTON) -> **4-F2** (MOVE/CHANGE BUTTON)
- INITIALIZING TO FACTORY SETTING VALUE
(CLEAR ALL DATA AND SET DEFAULT VALUE OF PROGRAM SETTING ITEM)

SETTING ITEM	FND DISPLAY	DESCRIPTION
4. FACTORY SET	<p>TICKETS</p>  <p>TIME</p> 	SELECT [ye] or [no] BY PRESSING SELECT BUTTON AND MOVE TO [ye] BY CURSOR





1	2	3	4
 MENU/SELECT	 MOVE/CHANGE		 MENU/SELECT
EXECUTE	CHECK FLICKERING [ye] ITEM		CHECK [ye] SELECT [OK] FLICKERING
	<p>TICKETS TIME</p>  <p>TICKETS TIME</p> 	<p>TICKETS TIME</p>  <p>TICKETS TIME</p> 	<p>TICKETS TIME</p>  <p>TICKETS TIME</p> 













3-4. TEST MODE









5. TEST MODE













- OPERATION TEST















※ TEST MODE HOW TO OPERATE SELECT CHECK BUTTON



1	2	3	4
 MENU/SELECT	 MOVE/CHANGE	 or  MENU/SELECT SHOOT	 CANCEL/SERVICE
ENTER SETUP MODE	MOVE TO TEST MENU ITEM	OPERATE TEST ITEM ON/OFF	EXIT (TO PREVIOUS MENU)

TEST ITEM	FND DISPLAY	DESCRIPTION
51. INPUT TEST	TICKETS  TIME 	CHECK INPUT STATUS OF BUTTON AND SENSOR (TO BE PLAYED BY SOUND WHEN INPUT STATUS OF EACH BUTTON AND SENSOR IS CHECKED) BASICALLY INPUT STATUS NUMBER IS DISPLAYED IN THE 1ST PLACE OF TIME FND
	TIME 	0. SETUP MENU/SELECT BUTTON [Sound: ZERO]
	TIME 	1. LEFT SHOOT BUTTON [Sound: ONE]
	TIME 	2. RIGHT SHOOT BUTTON [Sound: TWO]
	TIME 	3. GOAL IN HOLE SENSOR [Sound: THREE]
	TIME 	4. BALL MOUNTING SENSOR [Sound: FOUR]
	TIME 	5. COIN SELECTOR SENSOR 1 [Sound: FIVE]
	TIME 	6. COIN SELECTOR SENSOR 2 [Sound: SIX]
	TIME 	7. BILL ACCEPTER SIGNAL [Sound: SEVEN]
	TIME 	8. TICKET EMPTY BUTTON [Sound: EIGHT]
	TIME 	DISPLAY OF INPUT STATUS IN THE 2ND PLACE OF TIME FND 9. GOALKEEPER MOTOR CHECK SENSOR[Sound: NINE]











52. LAMP & FND	<p>TICKETS  TIME </p>	<p>LAMP, FND, LED TEST SELECT or SHOOT BUTTON :TEST BY PRESSING IN SEQUENCE OF [STEP] ▶ [ON] ▶ [ON/OFF] ▶ [OFF]</p> <p>[STEP] : TEST IN SEQUENCE AS BELOW ▶ LAMP : LEFT SHOOT BUTTON LAMP ON ▶ LAMP : RIGHT SHOOT BUTTON LAMP ON ▶ FND : TOTAL ON, OFF FLICKERING ▶ FND : DISPLAY [12] [34] IN SEQUENCE ▶ FND : DISPLAY TOTAL [11] [11] ~ [99] [99] NUMBER COUNT ▶ LED : GREEN LED AT TABLE FLANGE ON ▶ LED : FLICKERING OF GOAL IN HOLE ACRYL IN SEQUENCE OF WHITE, RED, GREEN, BLUE [ON] : STATUS OF TOTAL LAMP, FND, LED ON [ON/OFF] : ON/OFF TOTAL LAMP, FND, LED AT AN INTERVAL OF ONE SECOND [OFF] : STATUS OF TOTAL OFF (FND : DISPLAY OF CURRENT MENU ITEM [52] [--])</p>
53. GOALKEEPER MOTOR	<p>TICKETS  TIME </p>	<p>GOALKEEPER MOTOR TEST SELECT or SHOOT BUTTON : MOTOR OPERATION "ON" / "OFF"</p> <p>TIME  DISPLAY OF MOTOR OPERATION STATUS IN THE 1ST PLACE OF TIME FND [0-] : MOTOR ON, [--] : MOTOR OFF</p> <p>TIME  DISPLAY OF GOALKEEPER SENSOR CHECK COUNT IN THE 2ND PLACE OF TIME FND</p> <p>TIME  DISPLAY OF GOALKEEPER SENSOR ON/OFF IN THE 2ND PLACE OF TIME FND DOT</p>
54. TICKET	<p>TICKETS  TIME </p>	<p>TICKET DISPENSER TEST SELECT OR SHOOT BUTTON : TICKET DISPENSER "ON" / "OFF" (3 -> 2 -> 1 -> 0 DISPENSED TICKETS, 3 TICKETS OUT</p>













55. SOLENOID	TICKETS  TIME 	SOLENOID TEST SELECT BUTTON : AUTOMATIC OPERATION OF SOLENOID "ON", "OFF" REPETITION OF OPERATION FROM LEFT SOLENOID TO RIGHT SOLENOID LEFT SHOOT BUTTON : LEFT SOLENOID #1 "ON", "OFF" RIGHT SHOOT BUTTON : RIGHT SOLENOID #1 "ON", "OFF" TO PREVENT OVER LOAD AT SOLENOID TEST, RETEST IS POSSIBLE AFTER WAITING ONE SECOND FROM SWITCHING ON (WAIT FOR ONE SECOND AFTER SWITCHING ON)
	TIME 	DISPLAY OF LEFT SOLENOID OPERATION STATUS "1" IN THE 1ST PLACE OF TIME FND.WHEN IT IS BEING OPERATED, LEFT SHOOT BUTTON LAMP IS SWITCHED ON
	TIME 	DISPLAY OF RIGHT SOLENOID OPERATION STATUS "2" IN THE 2ND PLACE OF TIME FND. WHEN IT IS BEING OPERATED, RIGHT SHOOT BUTTON LAMP IS SWITCHED ON
56. COIN	TICKETS  TIME 	COIN SELECTOR TEST SELECT or SHOOT BUTTON : COIN SELECTOR OPERATION "ON" / "OFF". STATUS OF COIN SELECTOR "ON" IS DISPLAYED BY FLICKERING OF TIME FND
	TIME 	COIN SELECTOR 1 SENSOR CHECK COUNT IS DISPLAYED IN THE 1ST PLACE OF TIME FND. STATUS OF COIN SELECTOR SENSOR IS DISPLAYED BY LEFT SHOOT BUTTON(On / Off)
	TIME 	COIN SELECTOR 2 SENSOR CHECK COUNT IS DISPLAYED IN THE 2ND PLACE OF TIME FND STATUS OF COIN SELECTOR SENSOR IS DISPLAYED BY RIGHT SHOOT BUTTON (On / Off)
57. BILL	TICKETS  TIME 	BILL ACCEPTER TEST SELECT or SHOOT BUTTON : BILL ACCEPTER OPERATION "ON" / "OFF". STATUS OF BILL ACCEPTER "ON" IS DISPLAYED BY FLICKERING OF TIME FND
	TIME 	DISPLAY OF BILL ACCEPTER SENSOR CHECK COUNT IN THE 2ND PLACE OF TIME FND
	TIME 	DISPLAY OF BILL ACCEPTER SENSOR ON/OFF IN THE 2ND PLACE OF TIME FND DOT









58. COUNTER	TICKETS 	COUNTER TEST SELECT or SHOOT BUTTON : COIN IN AND TICKET OUT COUNTER OPERATES AT AN INTERVAL OF ONE SECOND
	TIME 	
	TIME 	DISPLAY OF COIN IN COUNER OPERATION IN THE 1ST PLACE OF TIME FND
	TIME 	DISPLAY OF TICKET OUT COUNER OPERATION IN THE 2ND PLACE OF TIME FND
59. SOUND	TICKETS 	SOUND TEST SELECT BUTTON : AUTOMATIC PLAY OF SOUND, ON/OFF TEST SHOOT BUTTON : PLAY OF SOUND (ONE TIME)
	TIME 	
	TIME 	DISPLAY OF SOUND PLAY "ON" IN THE TIME FND
60. BALL MOUNTED MOTOR	GOALS TIME 	BALL MOUNTING MOTOR TEST SELECT or SHOOT BUTTON : MOTOR OPERATION "ON" / "OFF"
	GOALS TIME 	
	TIME 	DISPLAY OF MOTOR OPERATION STATUS IN THE 1ST PLACE OF TIME FND [o-] : MOTOR ON, [--] MOTOR OFF
	TIME 	DISPLAY OF BALL MOUNTING MOTOR SENSOR CHECK COUNT IN THE 2ND PLACE OF TIME FND
	TIME 	DISPLAY OF BALL MOUNTING SENSOR ON/OFF STATUS IN THE 2ND PLACE OF TIME FND DOT
EXIT	TICKETS 	EXIT (TO PREVIOUS MENU)
	TIME 	

5. EXIT - EXIT TO OPERATION OPTIONS		
SETTING ITEM	FND DISPLAY	DESCRIPTION
5. EXIT	TICKETS  TIME 	EXIT TO OPERATION OPTIONS

3-5. ERROR CODE

ERROR CODE			
ERROR CODE FND DISPLAY	ERROR TYPE	DESCRIPTION	CHECK POINTS
TICKETS TIME 	SYSTEM	PROBLEM AT MAIN BOARD BACK-UP MEMORY (FRAM)	REPLACE MAIN BOARD IF PROBLEM IS STILL NOT FIXED AFTER TURNING POWER OFF AND ON
TICKETS TIME 		PROBLEM AT SETUP STORAGE DATA	1. PERFORM FACTORY SETTING 2. CHECK SET UP AND SAVE 3. REPLACE MAINBOARD IF PROBLEM IS STILL NOT FIXED
TICKETS TIME 		PROBLEM AT GAME STORAGE DATA	REPLACE MAIN BOARD IF PROBLEM IS STILL NOT FIXED AFTER TURNING POWER OFF AND ON
TICKETS TIME 	COIN SELECTOR	CONTINUOUS SENSOR SIGNAL AT COIN SELECTOR 1	1. OPERATION CHECK OF COIN SELECTOR 1 2. SENSOR INPUT CHECK OF COIN SELECTOR 1
TICKETS TIME 		CONTINUOUS SENSOR SIGNAL AT COIN SELECTOR 2	1. OPERATION CHECK OF COIN SELECTOR 2 2. SENSOR INPUT CHECK OF COIN SELECTOR 2
TICKETS TIME 	BILL ACCEPTER	CONTINUOUS SENSOR SIGNAL AT BILL ACCEPTER	1. OPERATION CHECK OF BILL ACCEPTER 2. SENSOR INPUT CHECK OF BILL ACCEPTER
TICKETS TIME 	GOAL KEEPER MOTOR	PROBLEM AT GOAL KEEPER MOTION SENSOR SIGNAL (NO SENSOR SIGNAL OR CONTINUOUS SIGNAL)	1. CHECK MOTOR OPERATION STATUS 2. CHECK INPUT STATUS OF MOTION SENSOR
TICKETS TIME 	BALL MOUNTING MOTOR	PROBLEM AT BALL MOUNTING MOTION SENSOR SIGNAL (NO SIGNAL OR CONTINUS SIGNAL)	1. CHECK MOTOR OPERATION STATUS 2. CHECK OPERATION SENSOR INPUT STATUS
TICKETS TIME 	GOAL IN HOLE SENSOR	CONTINUOUS GOAL IN HOLE SENSOR SIGNAL	1. CHECK BALL JAMMING STATUS 2. CHECK GOAL IN HOLE SENSOR STATUS
TICKETS TIME 	GOAL IN HOLE SENSOR	GOAL CHECK PROBLEM DUE TO FAILURE OF THE GOLA IN HOLE SENSOR	1. CHECK GOAL IN HOLE SENSOR STATUS
TICKETS TIME 	TICKET DISPENSOR	NO TICKET IN TICKET DISPENSOR	1. CHECK TICKET DISPENSOR

ERROR CODE ERROR DETECTION METHOD			
ERROR CODE FND DISPLAY	ERROR TYPE	DESCRIPTION	CHECK POINTS
TICKETS  TIME 	SYSTEM	PROBLEM AT SETUP STORAGE DATA	ERROR OCCURS IF THERE IS ANY PROBLEM READING SETUP BACK UP MEMORY AFTER POWER IS TURNED ON
TICKETS  TIME 		PROBLEM AT GAME STORAGE DATA	ERROR OCCURS IF THERE IS ANY PROBLEM READING GAME BACK UP MEMORY AFTER POWER IS TURNED ON
TICKETS  TIME 	COIN SELECTOR	CONTINUOUS SENSOR SIGNAL AT COIN SELECTOR 1	ERROR OCCURS IF SIGNAL IS CONTINUED MORE THAN 2 SECONDS WHILE INHIBIT IS ON
TICKETS  TIME 		CONTINUOUS SENSOR SIGNAL AT COIN SELECTOR 2	
TICKETS  TIME 	BILL ACCEPTER	CONTINUOUS SENSOR SIGNAL AT BILL ACCEPTER	ERROR OCCURS IF SIGNAL IS CONTINUED MORE THAN 2 SECONDS WHILE INHIBIT IS ON
TICKETS  TIME 	GOAL KEEPER MOTOR	PROBLEM AT GOALKEEPER OPERATION SENSOR SIGNAL (NO SIGNAL OR CONTINUOUS SIGNAL)	ERROR IF THERE IS NO SENSOR SIGNAL MORE THAN 5 SECONDS WHILE MOTOR IS OPERATING

<p>TICKETS  TIME </p>	<p>BALL MOUNTING MOTOR</p>	<p>PROBLEM AT BALL MOUNTING OPERATION SENSOR SIGNAL (NO SIGNAL OR CONTINUOUS SIGNAL)</p>	<p>IF THERE IS NO SENSOR SIGNAL FOR MORE THAN 3 SECONDS DURING MOTOR OPERATION, IT STOPS AND ROTATES IN REVERSE FOR 2 SECONDS AND THEN ROTATES FORWARD. IF THERE IS STILL NO SENSOR SIGNAL FOR 3 SECONDS DURING THIS PROCESS, ERROR OCCURS</p>
<p>TICKETS  TIME </p>	<p>GOAL IN HOLE SENSOR</p>	<p>CONTINUOUS GOAL IN HOLE SENSOR SIGNAL</p>	<p>ERROR IF THERE IS GOAL IN HOLE SENSOR SIGNAL MORE THAN 3 SECONDS DURING GAME PLAY. ERROR IF THERE IS CONTINUOUS GOAL IN HOLE SENSOR SIGNAL DUE TO SENSOR PROBLEM</p>
<p>TICKETS  TIME </p>	<p>GOAL IN HOLE SENSOR</p>	<p>GOAL CHECK PROBLEM DUE TO FAILURE OF THE GOAL IN HOLE SENSOR</p>	<p>IN CASE OF THE NUMBER OF GOAL CHECKS IS HIGHER THAN THE NUMBER OF TIMES THE BALL IS FIRED</p>
<p>TICKETS  TIME </p>	<p>TICKET DISPENSOR</p>	<p>NO TICKET IN TICKET DISPENSOR</p>	<p>ERROR IF THERE IS NO TICKET OUT SIGNAL MORE THAN 3 SECONDS AFTER TICKET OUT SIGNAL TO TICKET DISPENSOR</p>

4. TROUBLESHOOTING

* General check up : Check the supply voltage and wiring connection properly
 * "NO" : Means faulty of the check up result.

4-1. IN CASE OF GOALKEEPER MOTOR PROBLEM [Er. 31]

GOALKEEPER MOTOR

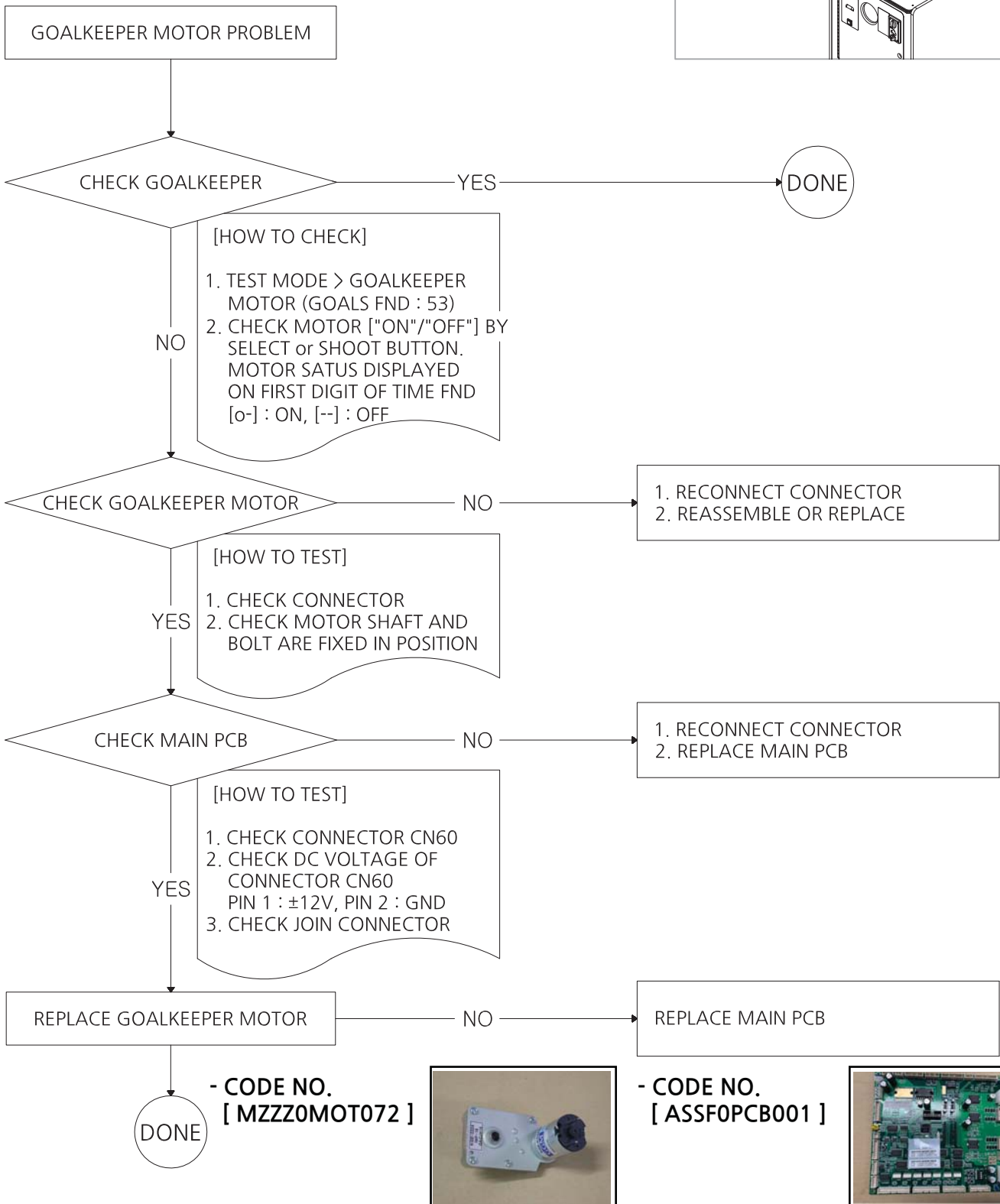
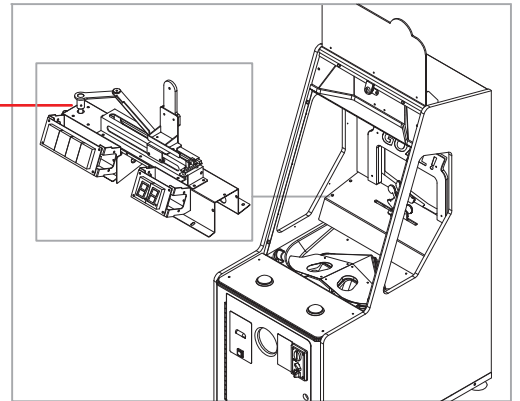

* General check up : Check the supply voltage and wiring connection properly
 * "NO" : Means faulty of the check up result.

4-2. IN CASE OF GOALKEEPER SENSOR PROBLEM [Er. 31]

GOALKEEPER SENSOR

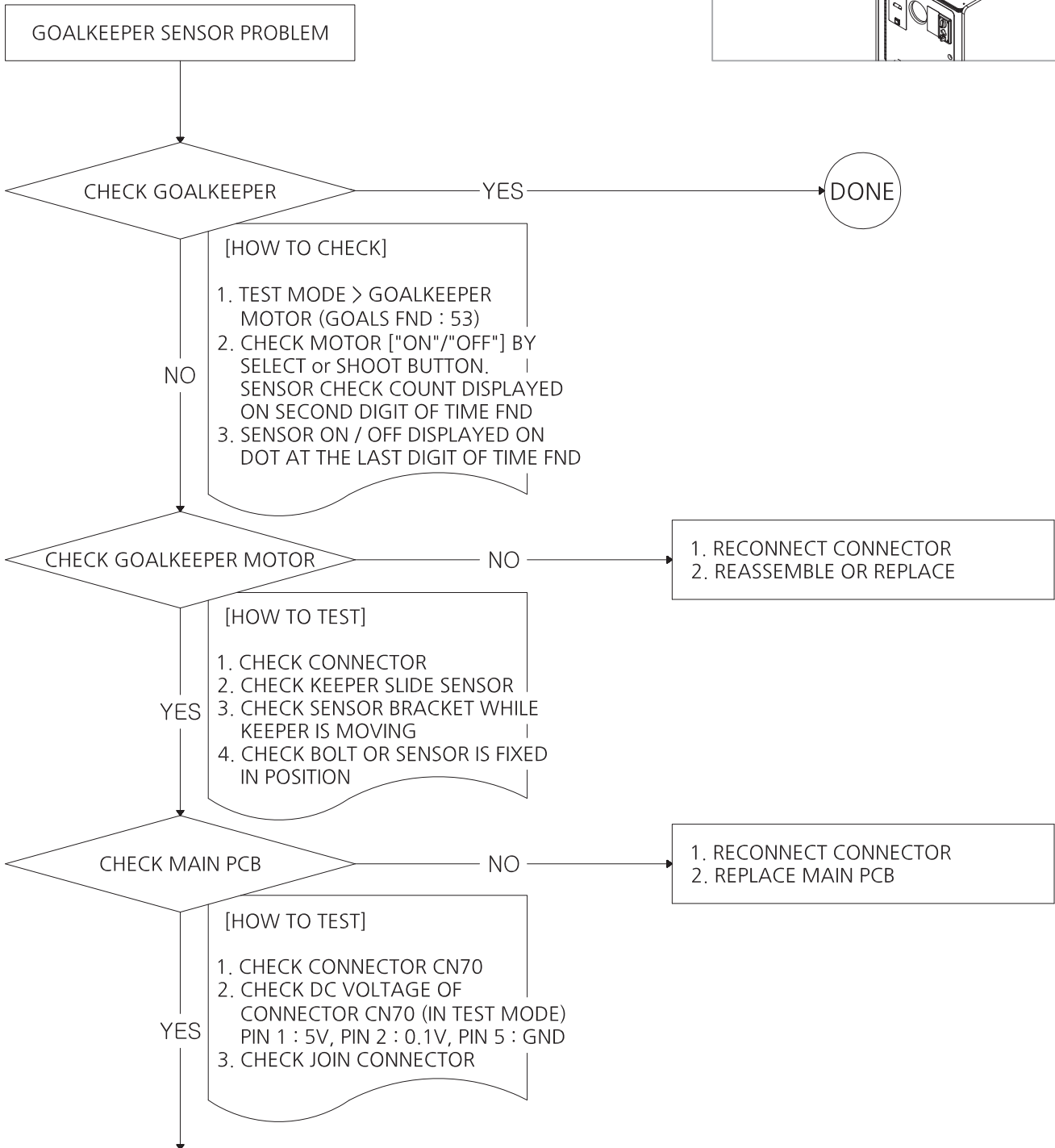
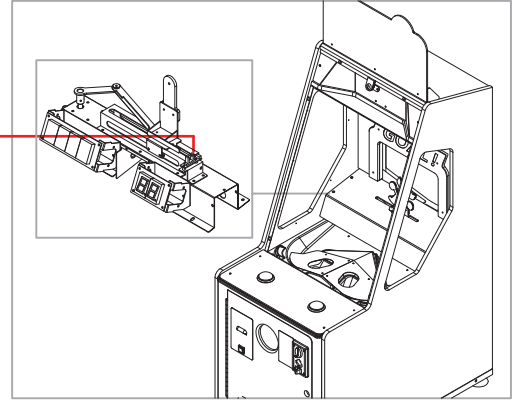

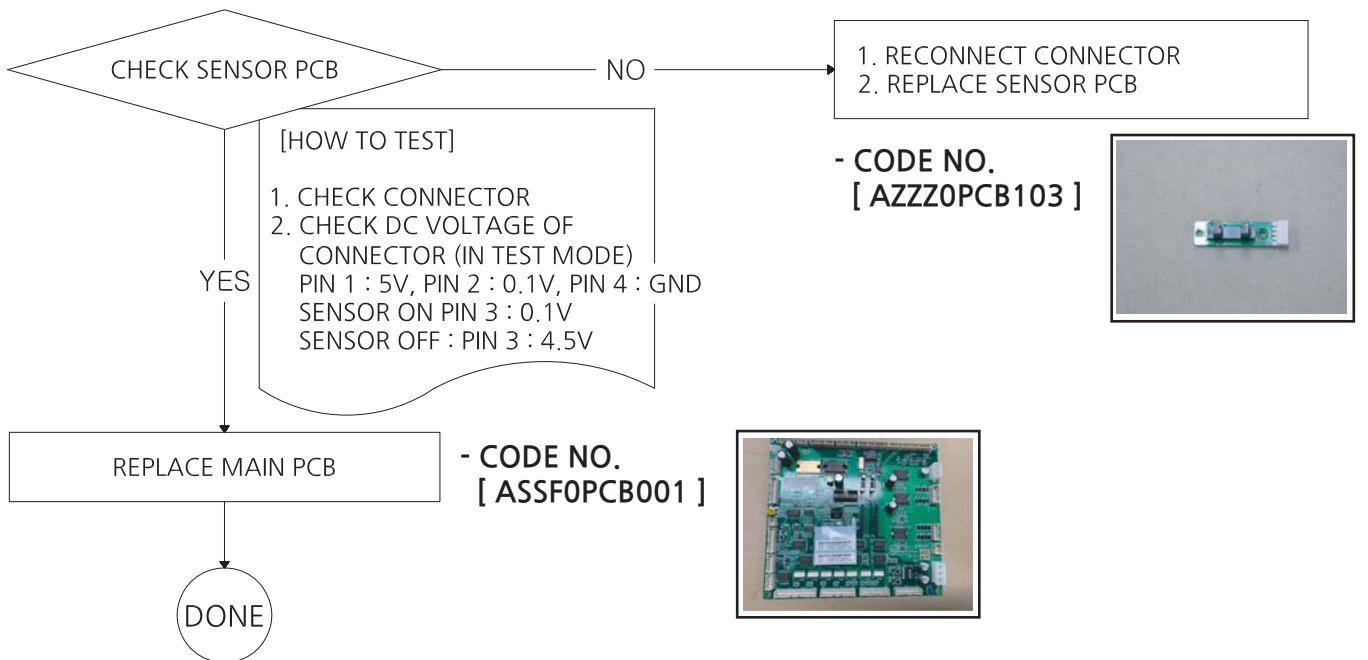

* General check up : Check the supply voltage and wiring connection properly
 * "NO" : Means faulty of the check up result.

4-3. IN CASE OF BALL LOADING MOTOR PROBLEM [ER. 41]

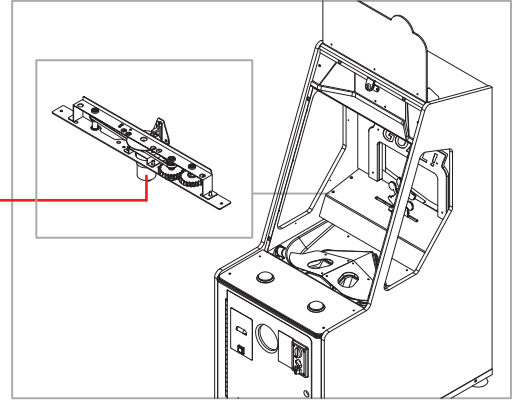

BALL LOADING MOTOR

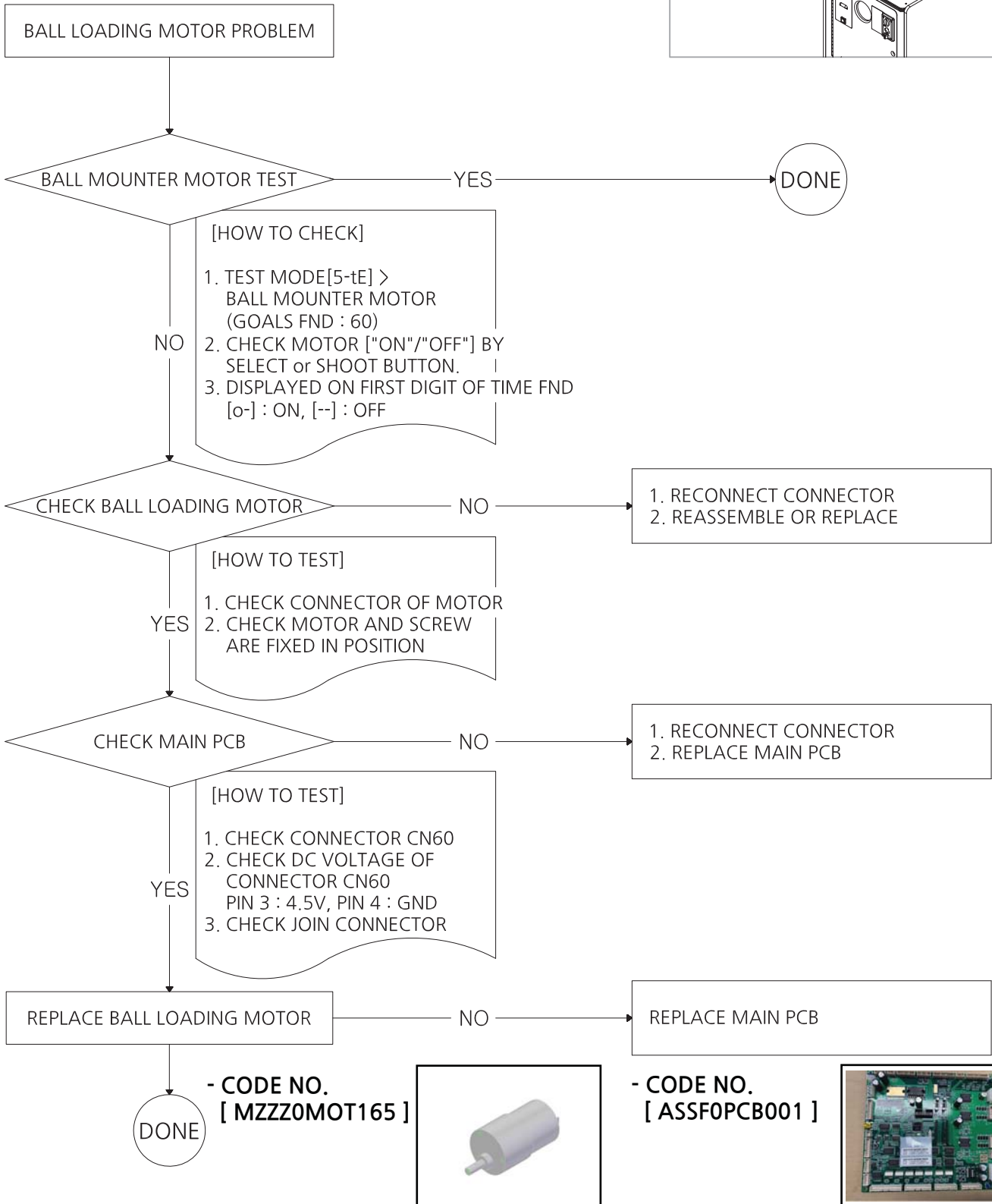

* General check up : Check the supply voltage and wiring connection properly
 * "NO" : Means faulty of the check up result.

4-4. IN CASE OF BALL LOADING MOTOR SENSOR PROBLEM [ER. 41]

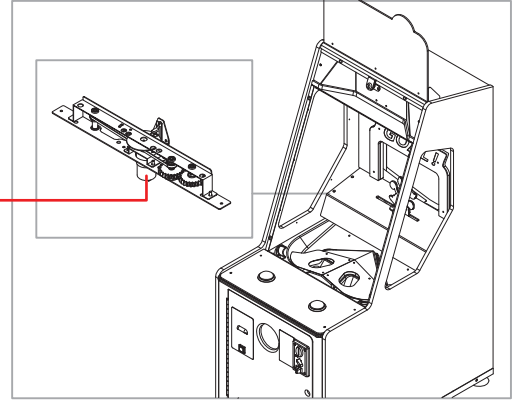

BALL LOADING MOTOR

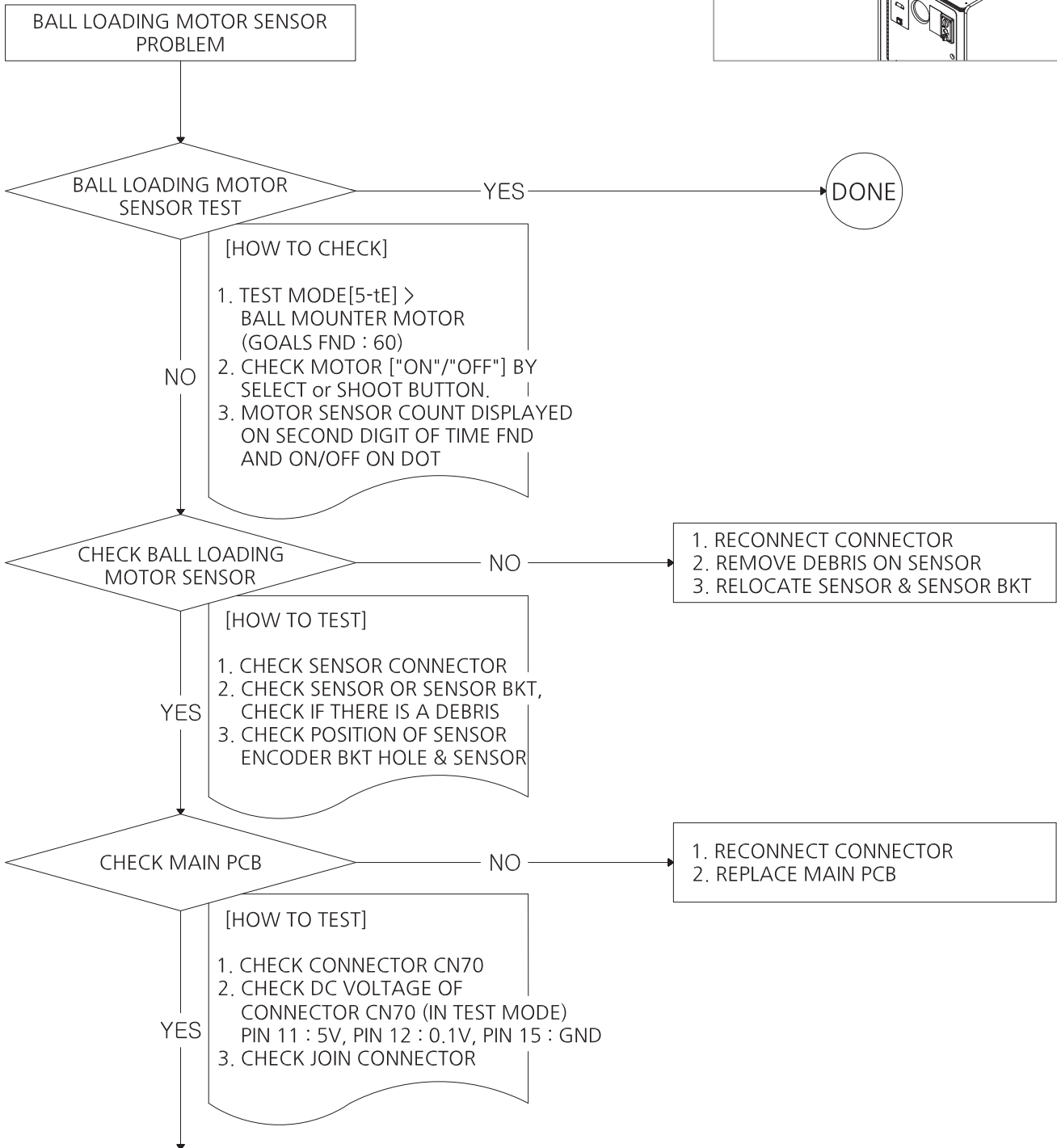

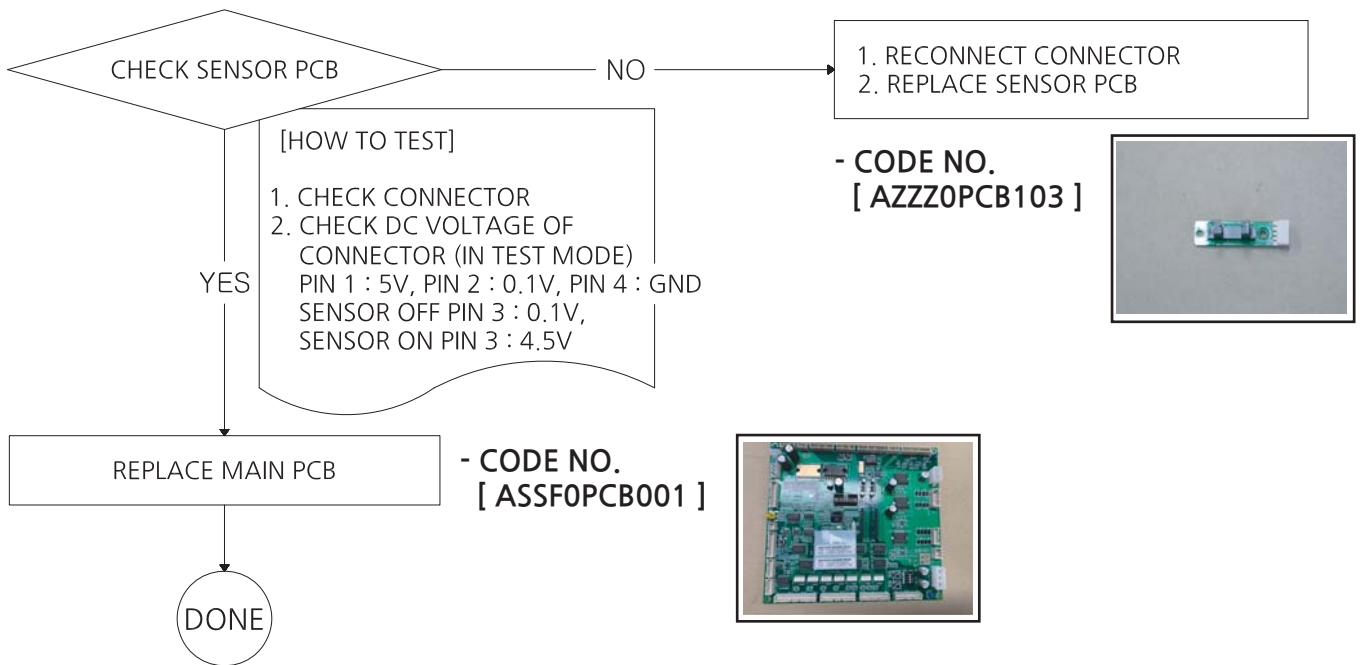

- * General check up : Check the supply voltage and wiring connection properly
- * "NO" : Means faulty of the check up result.

4-5. IN CASE OF GOAL IN HOLE SENSOR PROBLEM [ER. 71, 72]

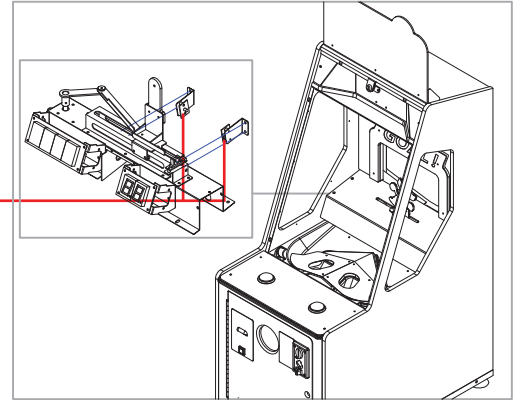

GOAL IN HOLE SENSOR

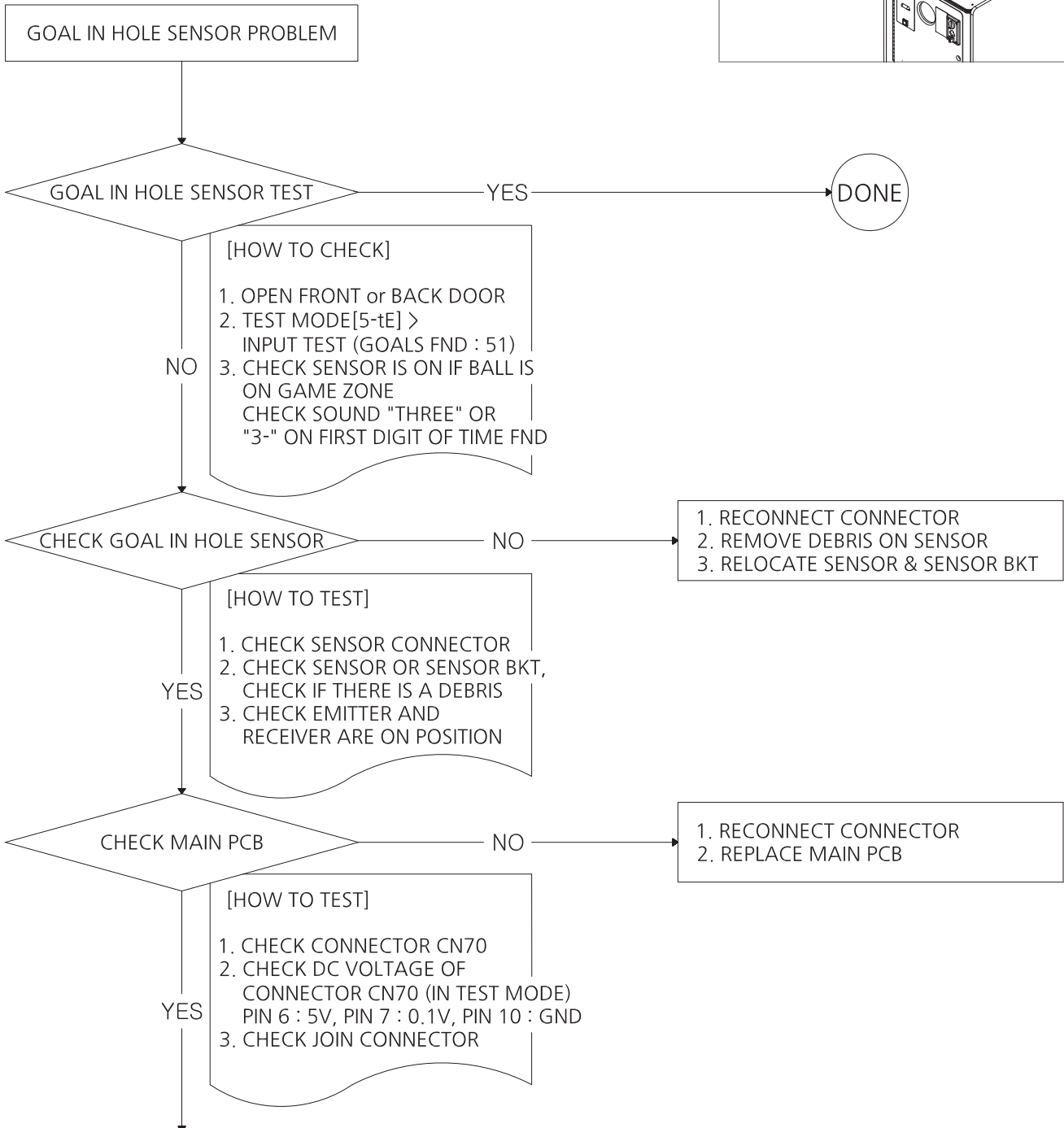

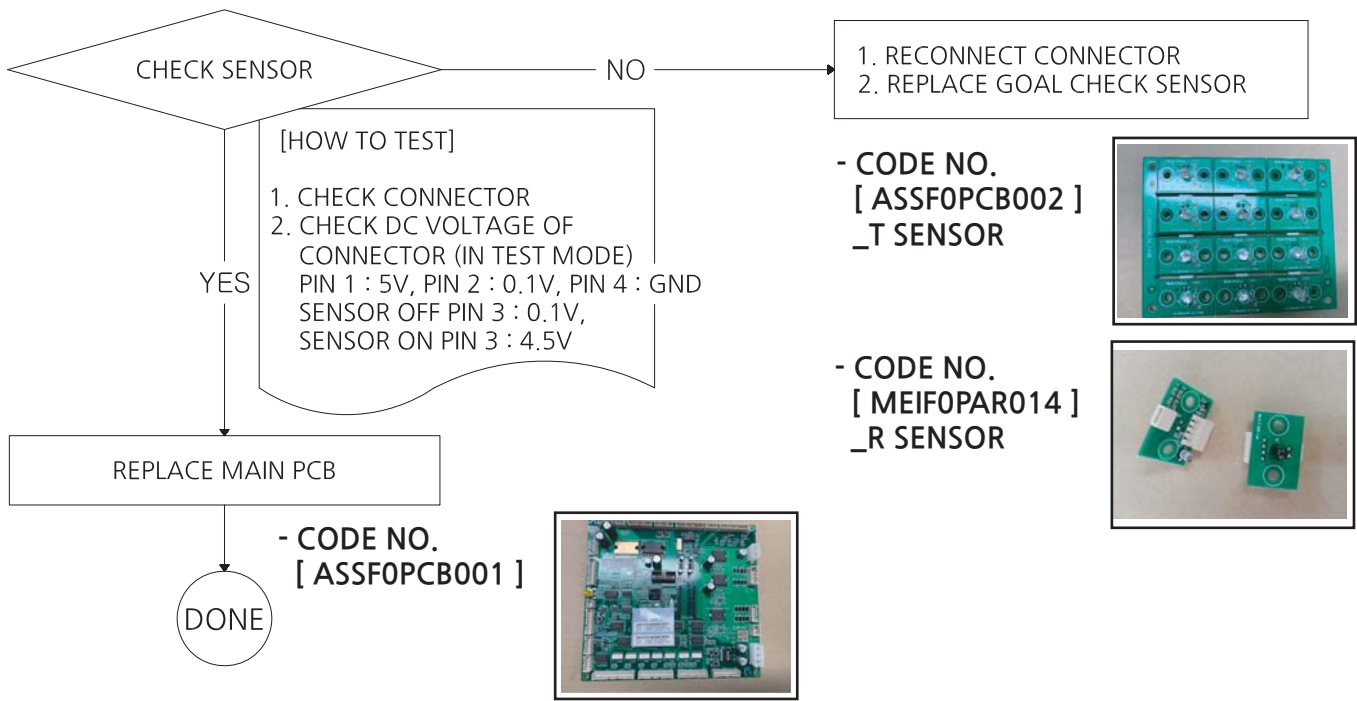

* General check up : Check the supply voltage and wiring connection properly
 * "NO" : Means faulty of the check up result.

4-6. IN CASE OF SOLENOID LEFT PROBLEM

SOLENOID LEFT

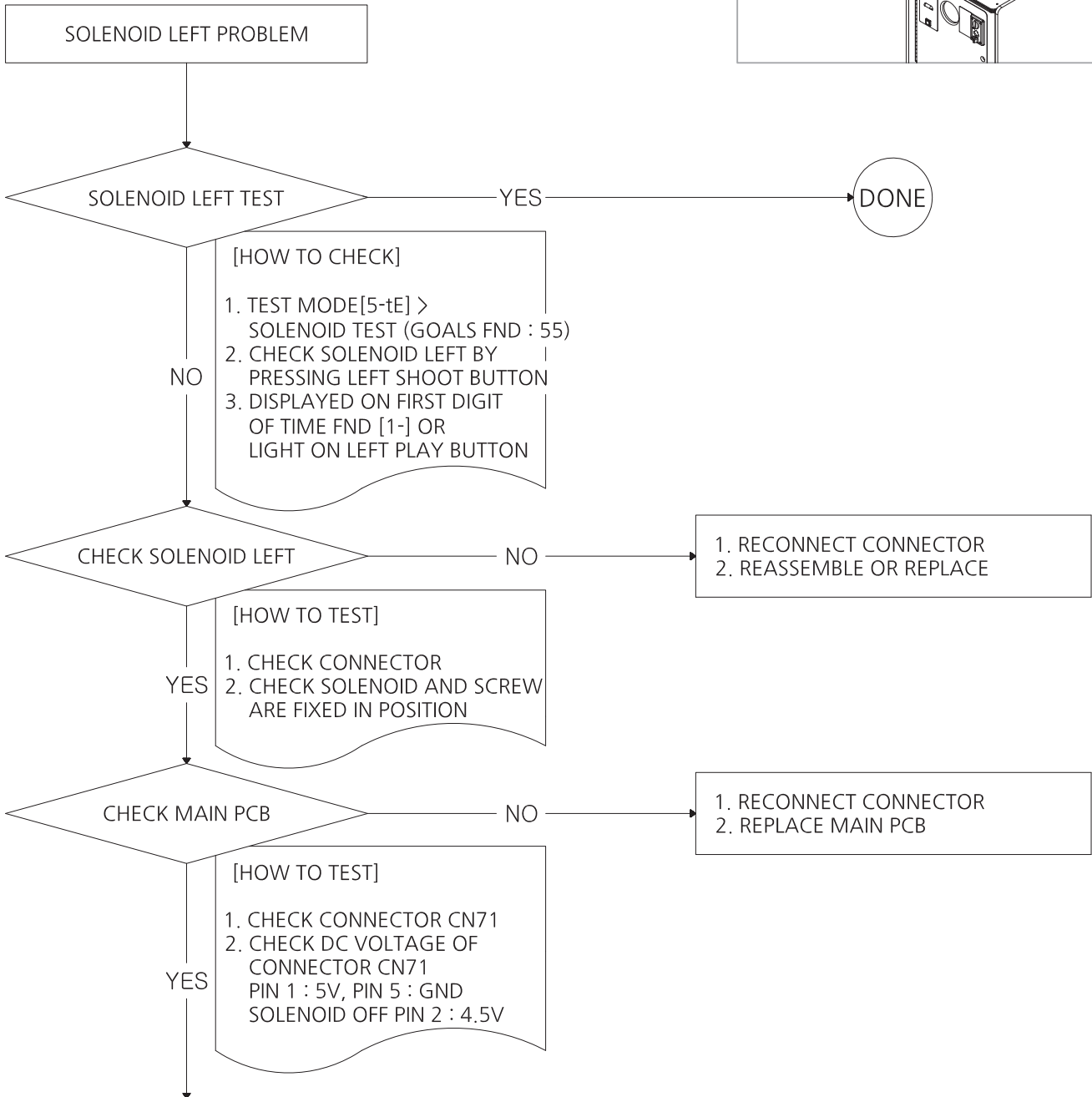
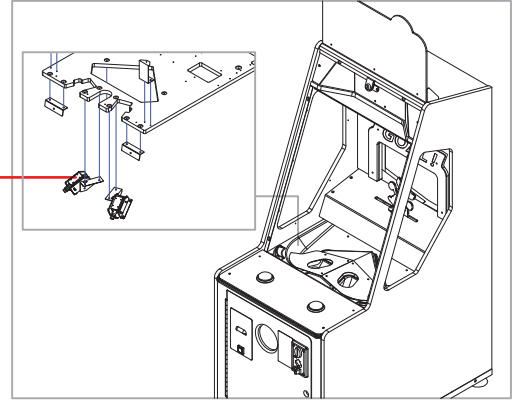

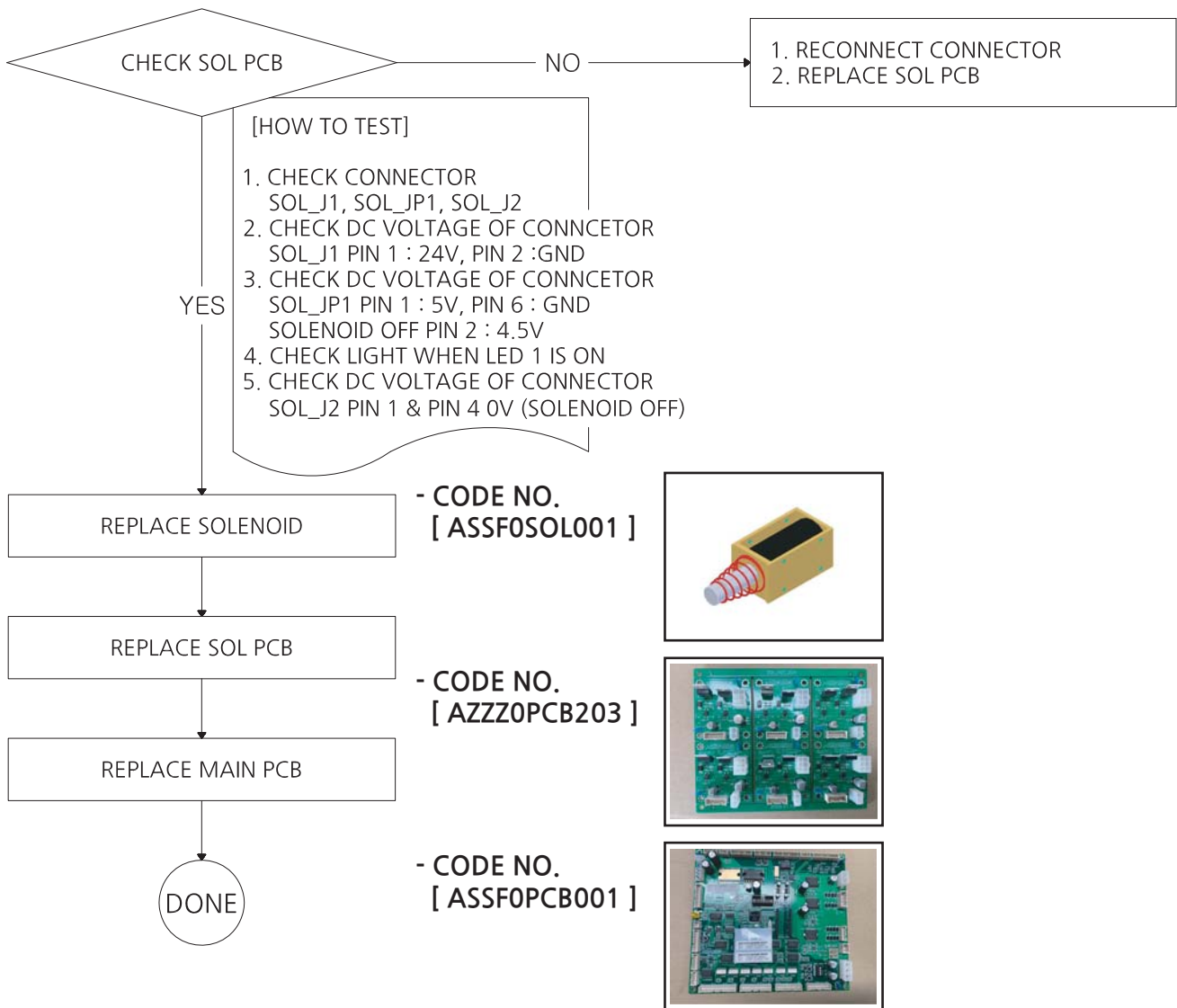

* General check up : Check the supply voltage and wiring connection properly
 * "NO" : Means faulty of the check up result.

4-7. IN CASE OF SOLENOID RIGHT PROBLEM

SOLENOID RIGHT

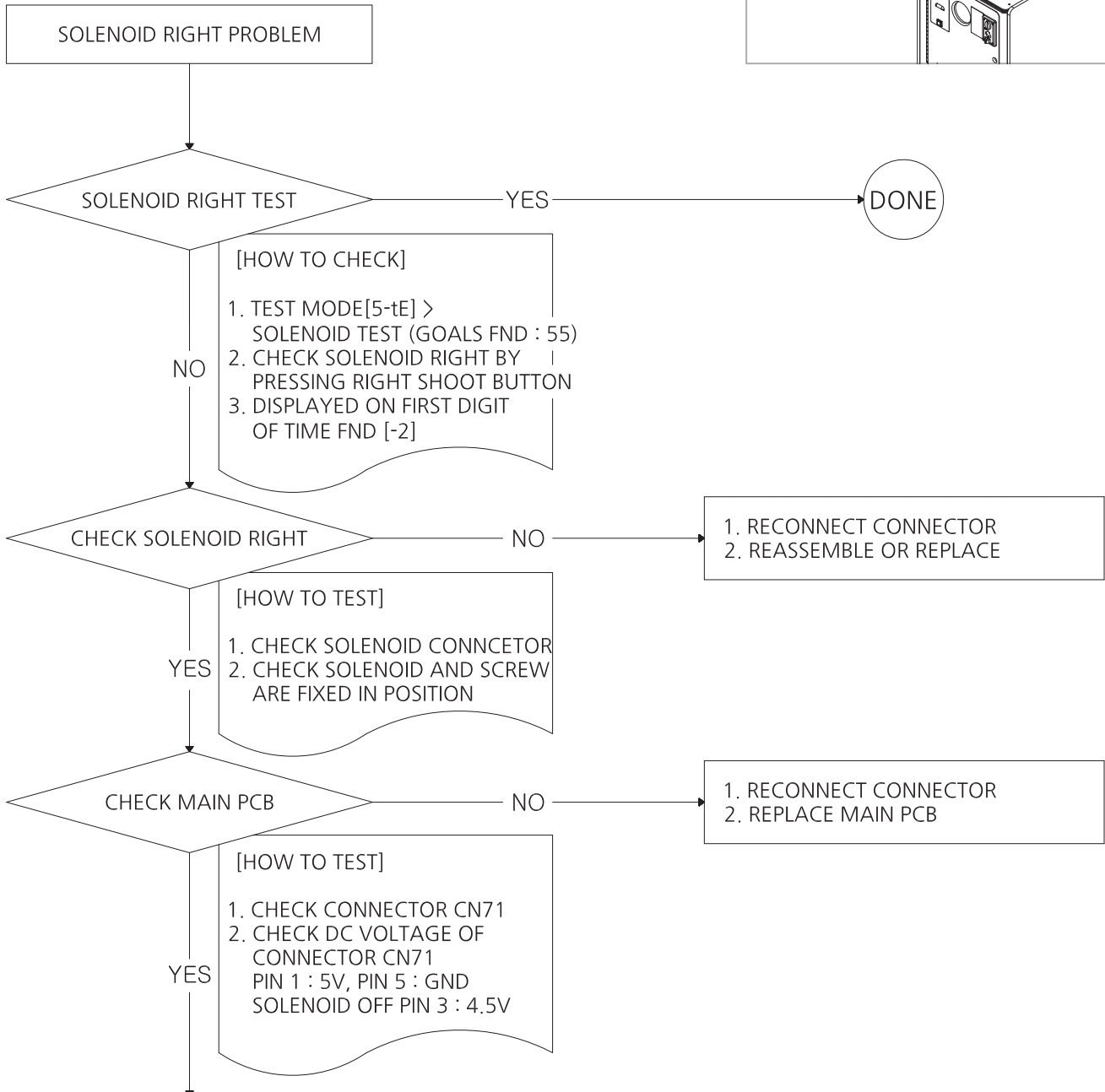
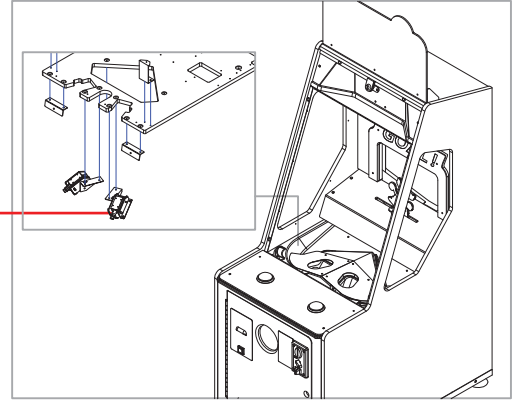

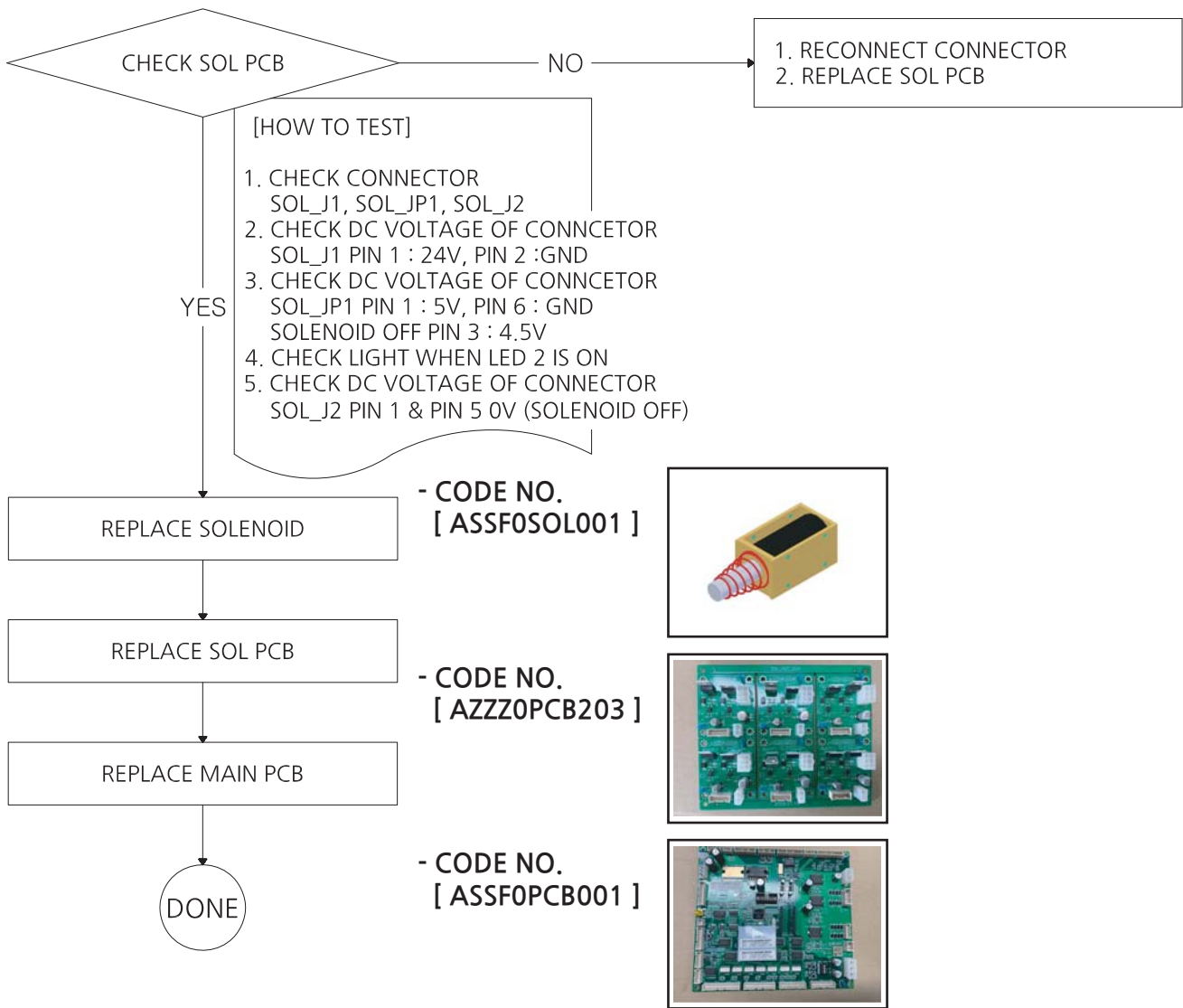

5. EXPLODED VIEW

5-1. MAIN CABINET PART

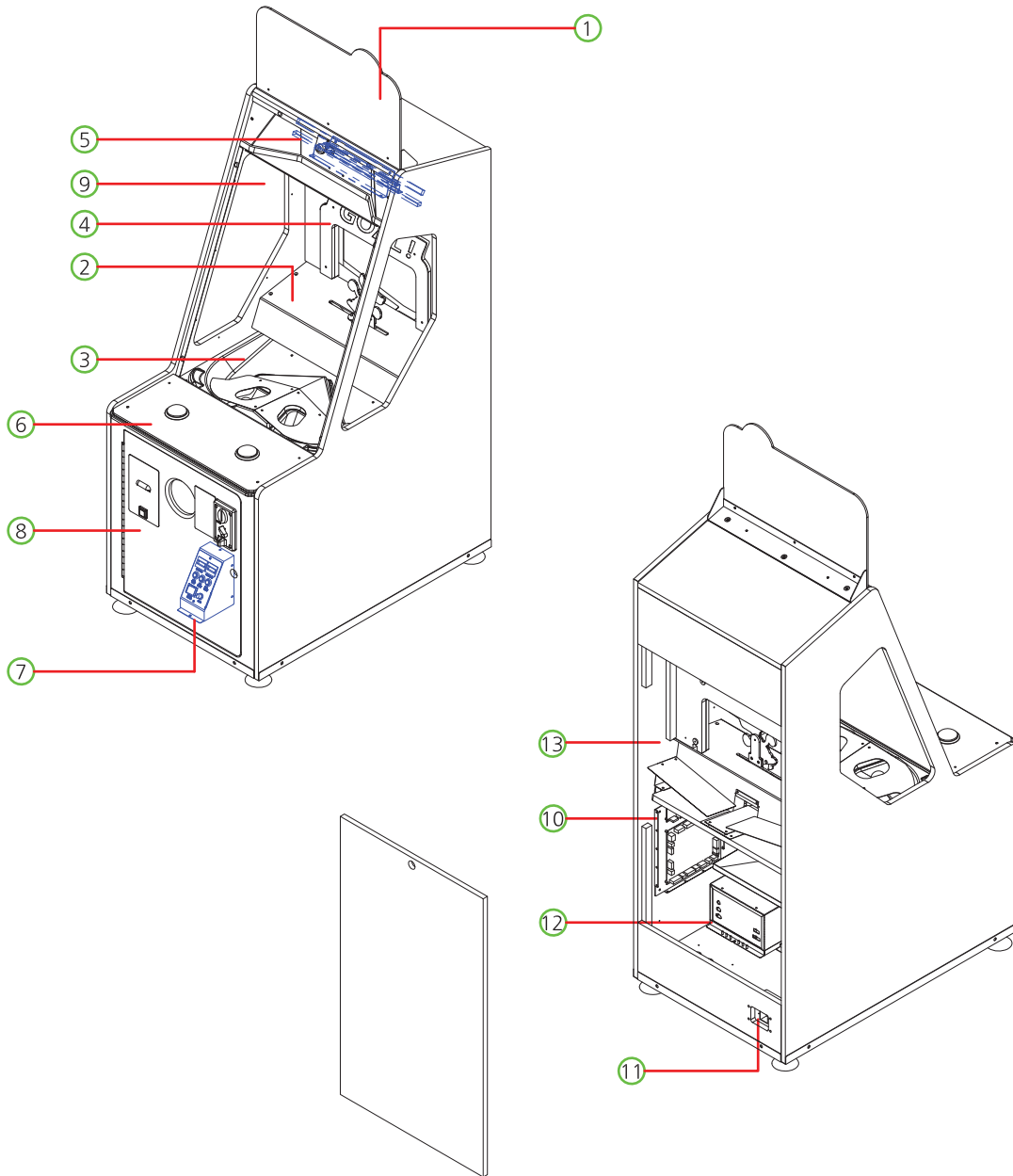

NO.	PART NAME	SPEC.	QUANTITY	CODE NO.
1	BILLBOARD PART	-	1	-
2	PLAYFIELD PART	-	1	-
3	BALL GROUND MOLD PART	-	1	-
4	GOAL POST PART	-	1	-
5	BILLBOARD LED PART	-	1	-
6	BUTTON PL ACRYL PART	-	1	-
7	SETUP PANEL PART	-	1	-
8	FRONT DOOR PART	-	1	-
9	FRONT GLASS DOOR PART	-	1	-
10	MAIN BOARD PCB PART	-	1	-
11	AC INPUT PART	-	1	-
12	SMPS BOX PART	-	1	-
13	MAIN CABINET REAR DOOR PART	-	1	-

5-2. BILLBOARD PART

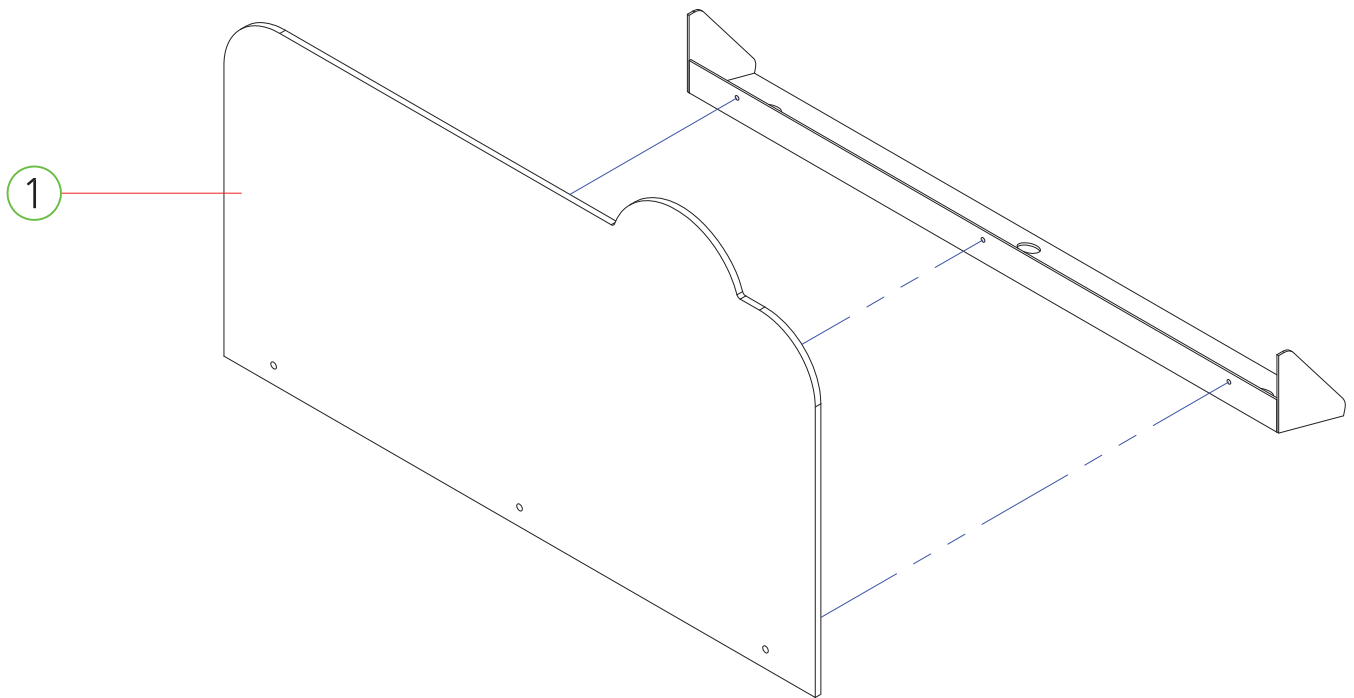

NO.	PART NAME	SPEC.	QUANTITY	CODE NO.
1	SOCCER TITLE_SPONGEBOB	FROMAX-5.0t	1	ASSFOACP010

5-3. PLAYFIELD PART

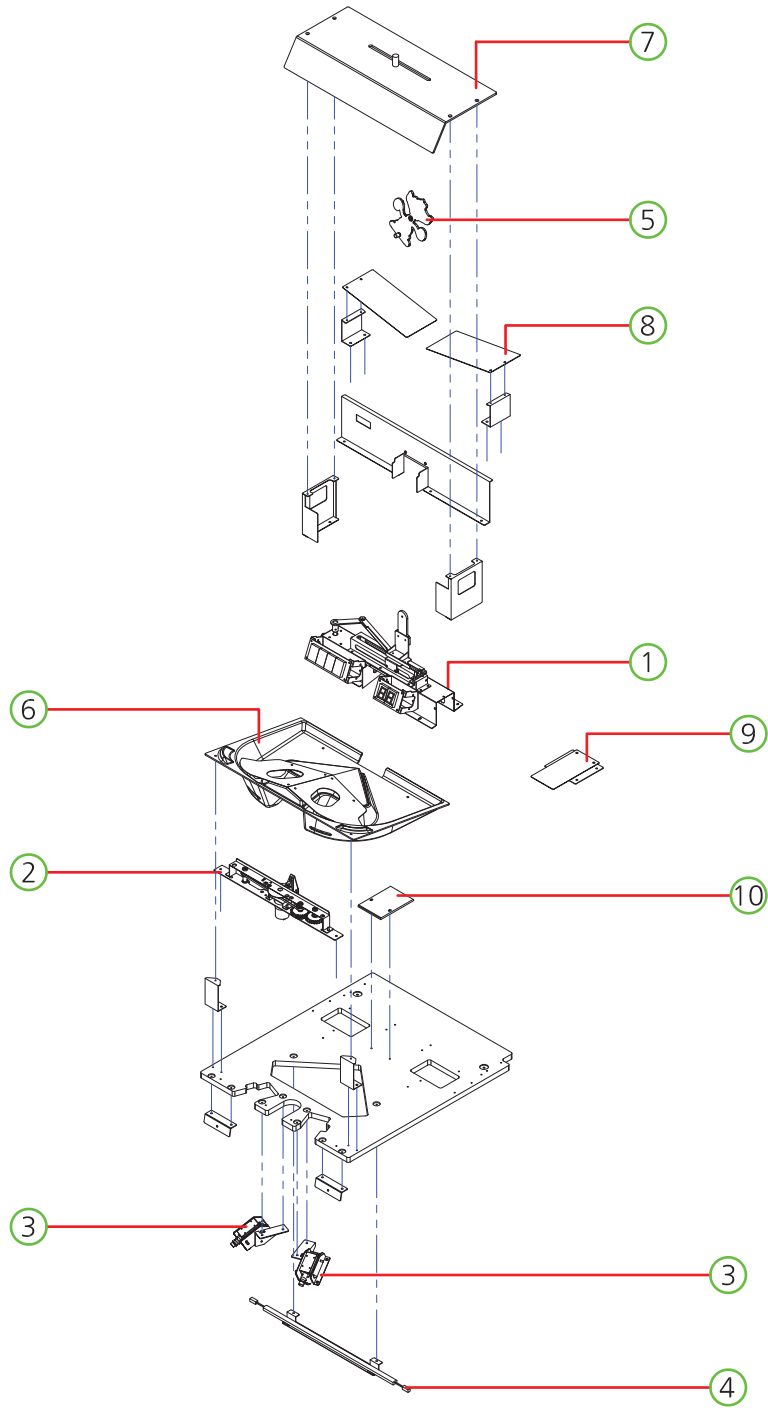

NO.	PART NAME	SPEC.	QUANTITY	CODE NO.
1	GOALKEEPER MOVING ASS'Y	-	1	-
2	BALL TRAFFIC JAM ASS'Y	-	1	-
3	SOLENOID ASS'Y	-	2	ASSF0SOL001
4	PLAYFIELD BOTTOM LED FIX BKT ASS'Y	-	1	-
5	GOALKEEPER ASS'Y	-	1	-
6	BALL GROUND MOLD ASS'Y	-	1	-
7	PLAYFIELD UPPER ACRYL	ACRYL-4.7t	1	MSSF0ACR004
8	BALL BUFFER PLATE	PC-1.0t	1	MSSF0ACR019
9	BALL BUFFER CENTER PLATE	PC-1.0t	1	MSSF0ACR018
10	GUIDE PL ACRYL	ACRYL-5.0t	1	MSSF0ACR011

5-4. GOALKEEPER MOVING PART

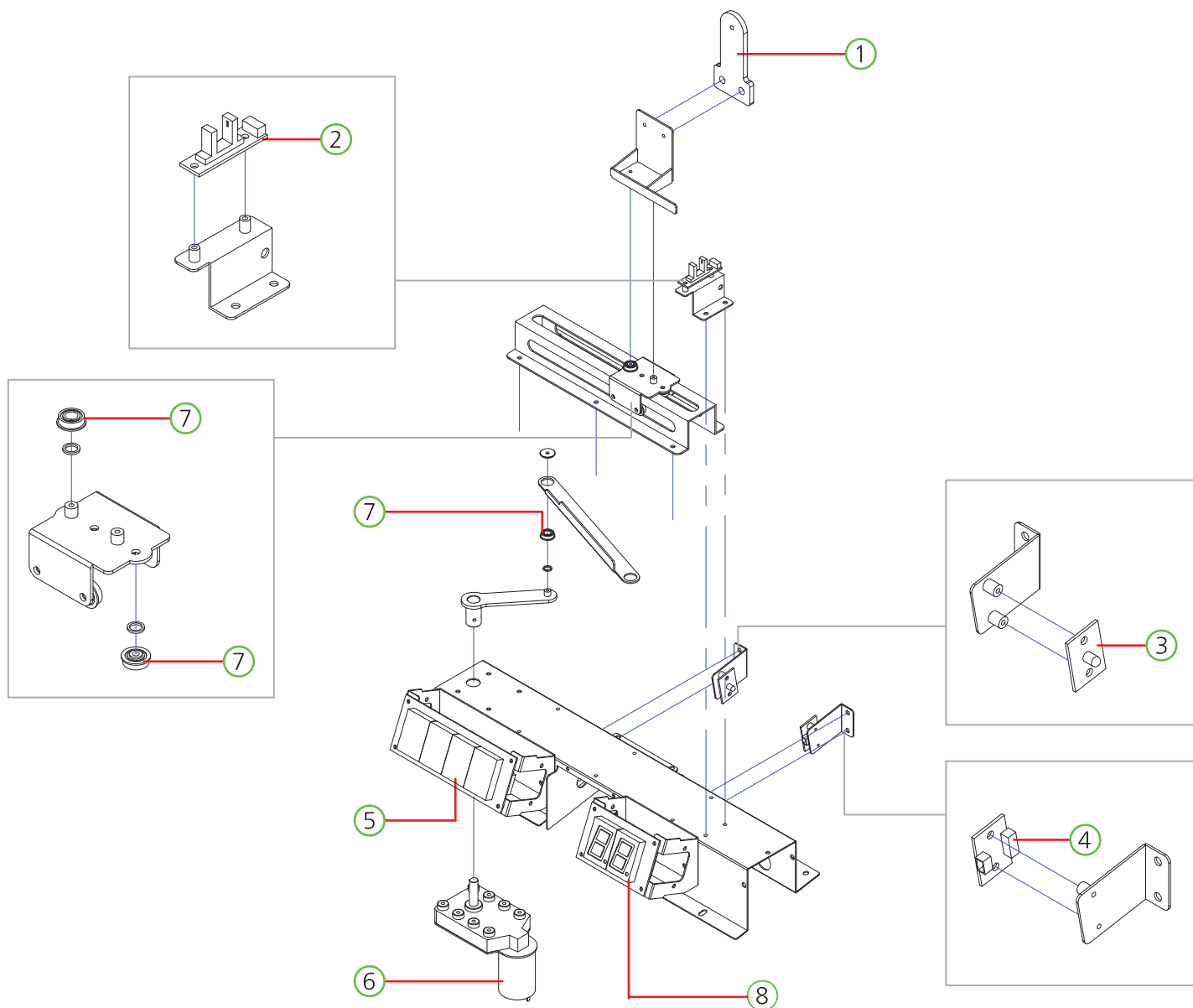

NO.	PART NAME	SPEC.	QUANTITY	CODE NO.
1	GOALKEEPER FIX ACRYL	-	1	MSSF0ACR010
2	PHOTO INT-1 PCB ASS'Y	-	1	AZZZ0PCB103
3	SENSOR_T PCB ASS'Y	-	1	ASSF0PCB002
4	SENSOR_R PCB ASS'Y	-	1	MEIF0PAR014
5	FND PCB ASS'Y	2941-4(STRAIGHT)	1	AFND0PCB004
6	MOTOR	KGE-3448-050-12V_1/204 F-TYPE	1	MZZZ0MOT072
7	BEARING	FMR126ZZ	3	MZZZ0BEA137
8	FND PCB ASS'Y	2941-02(STRAIGHT)	1	AFND0PCB003

5-5. BALL TRAFFIC JAM PART

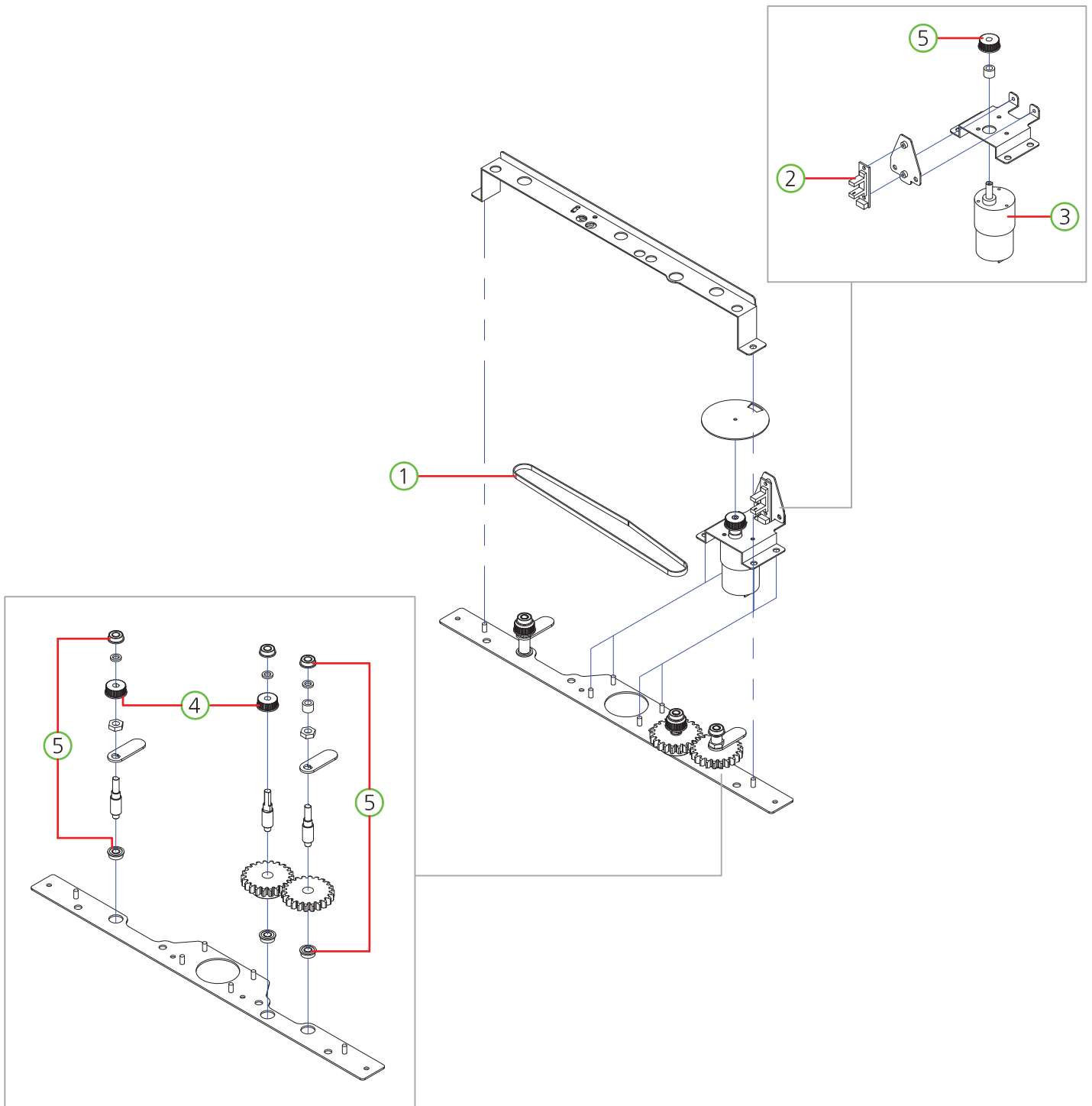

NO.	PART NAME	SPEC.	QUANTITY	CODE NO.
1	TIMMING BELT	232MXL,W4.8 RUBBER	1	MZZ0BEL048
2	PHOTO INT-1 PCB ASS'Y	ANGLE TYPE	1	AZZ0PCB103
3	MOTOR	KGC-0090-3429 50RPM(W/TAP)	1	MZZ0MOT165
4	TIMMING PULLEY	MXL-29	1	MZZ0PLA040
5	BEARING	F686ZZ	6	MZZ0BEA094

5-6. SOLENOID-1P, 2P PART

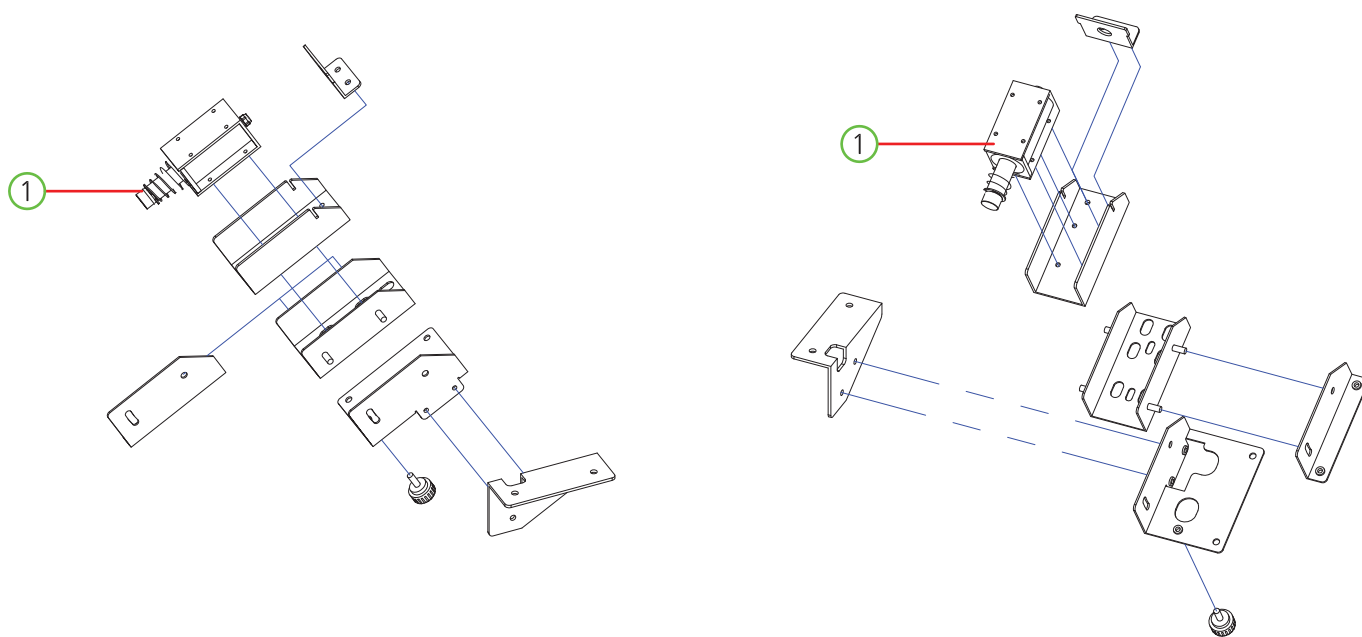

NO.	PART NAME	SPEC.	QUANTITY	CODE NO.
1	SOLENOID ASS'Y	-	2	ASSF0SOL001

5-7. PLAYFIELD BOTTOM LED FIX BKT PART

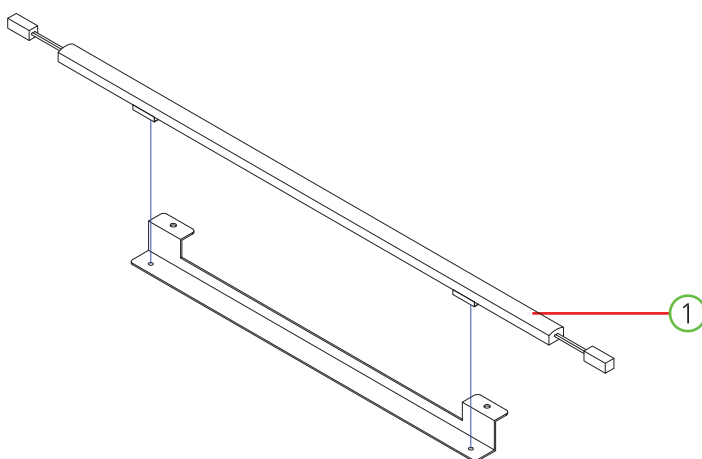

5-8. GOALKEEPER PART

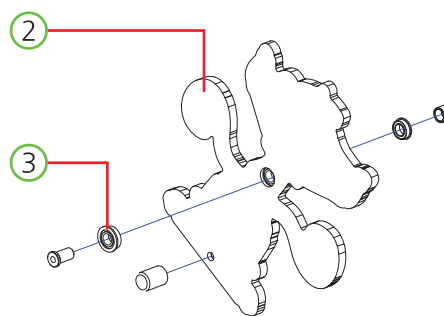

NO.	PART NAME	SPEC.	QUANTITY	CODE NO.
1	LED BAR 12V ASS'Y	460mm	1	AZZZ0PCB124
2	GOALKEEPER ACRYL	ACRYL-5.0t	1	ASSF0ACP008
3	BEARING	MF106ZZ	2	MZZZ0BEA138

5-9. BALL GROUND MOLD PART

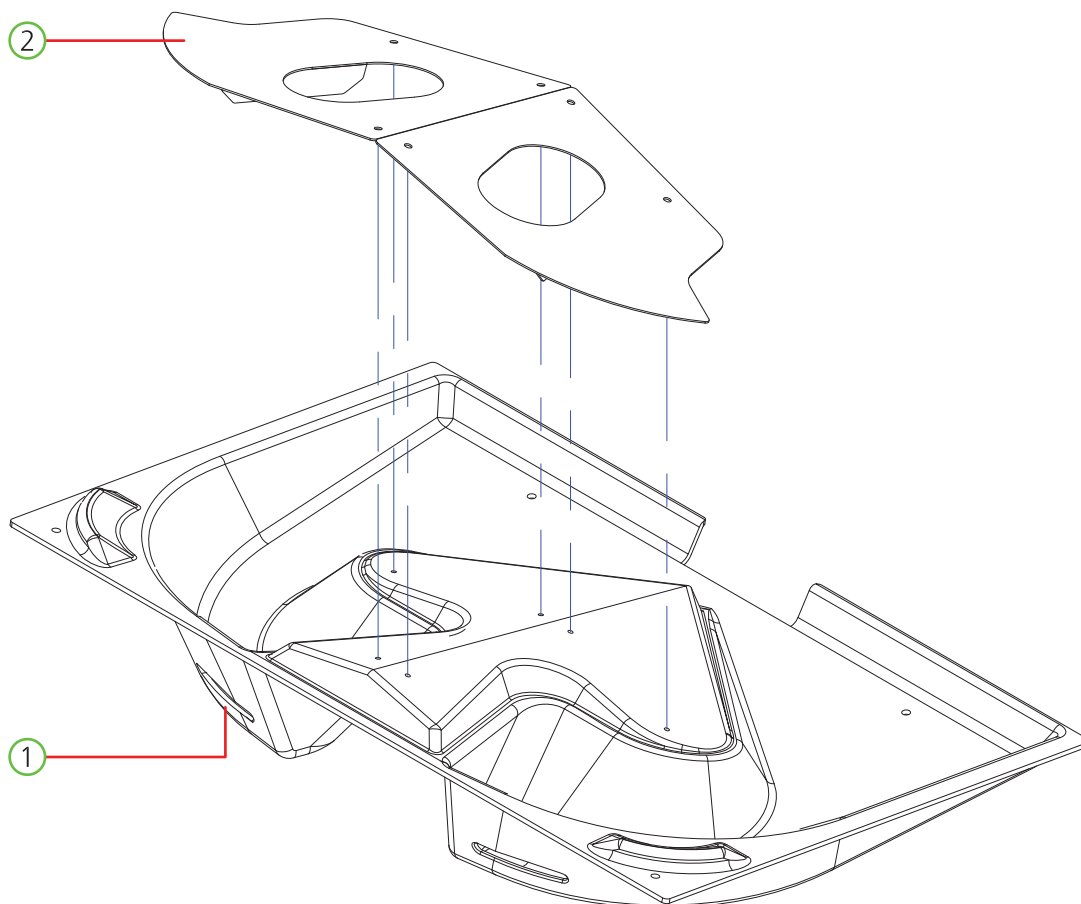

NO.	PART NAME	SPEC.	QUANTITY	CODE NO.
1	MOLD-BALL GROUND	PC-4.0t	1	MSSF0PLA001
2	ASS'Y-MOLD COVER ACRYL	PC-1.0t	2	ASSF0ACR001
				[MSSF0ACR016, 017]

5-10. GOAL POST PART

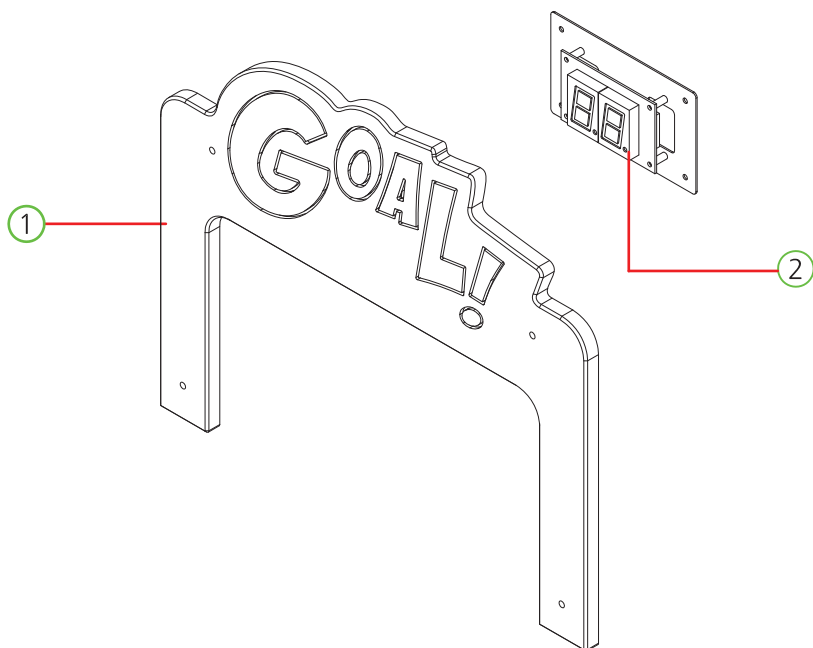

NO.	PART NAME	SPEC.	QUANTITY	CODE NO.
1	GOAL ACRYL	ACRYL-10.0t	1	ASSF0ACB011
2	FND PCB ASS'Y	2941-2(STRAIGHT)	1	AFND0PCB003

5-11. BILLBOARD LED PART

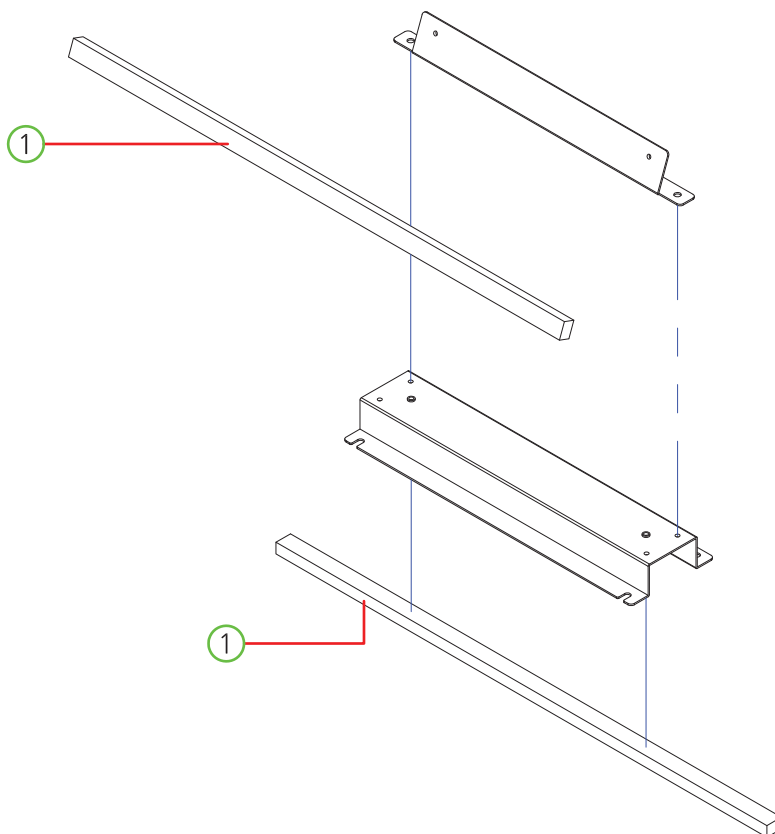

NO.	PART NAME	SPEC.	QUANTITY	CODE NO.
1	LED BAR 12V ASS'Y	460mm	2	AZZZ0PCB124

5-12. BUTTON ACRYL PART

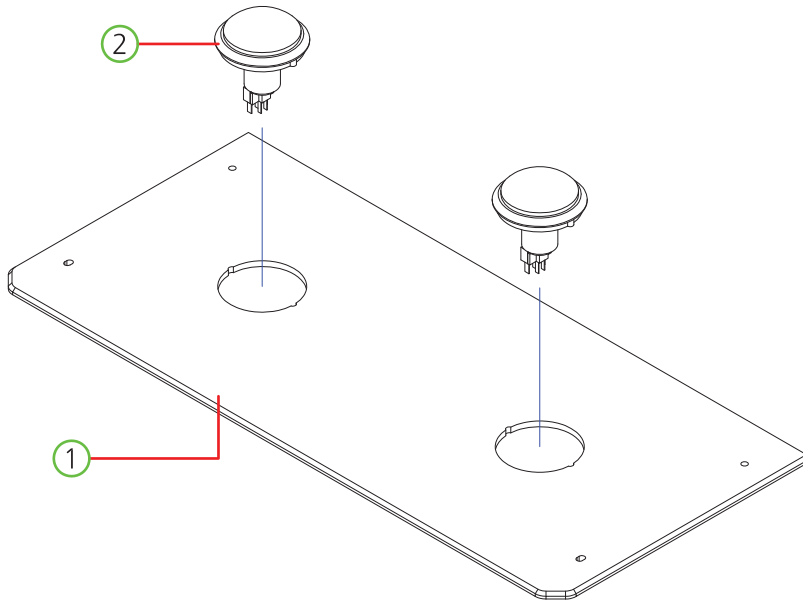

NO.	PART NAME	SPEC.	QUANTITY	CODE NO.
1	BUTTON PL ACRYL	ACRYL-4.7t	1	ASSF0ACP007
2	BUTTON SWITCH	AMIPB-60HR-W12D	2	MZZZ0BUT054

5-13. SETUP PANEL PART

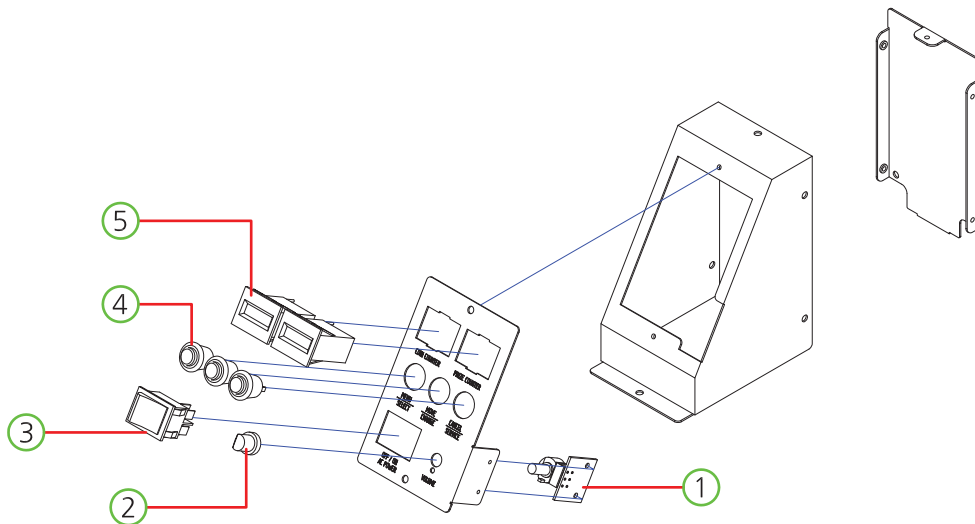

NO.	PART NAME	SPEC.	QUANTITY	CODE NO.
1	VOLUME PCB ASS'Y	1 VOLUME	1	AHM20PCB016
2	VOLUME KNOB	CAP BLUE	1	MELE0VOL007
3	ROCKER SWITCH	R595KDF	1	MELE0SWI021
4	PUSH BUTTON SWITCH	DS-412R ROSH	3	MELE0PUS006
5	COUNTER	OA127CL W/2P	2	MZZZ0COU002

5-14. FRONT DOOR PART

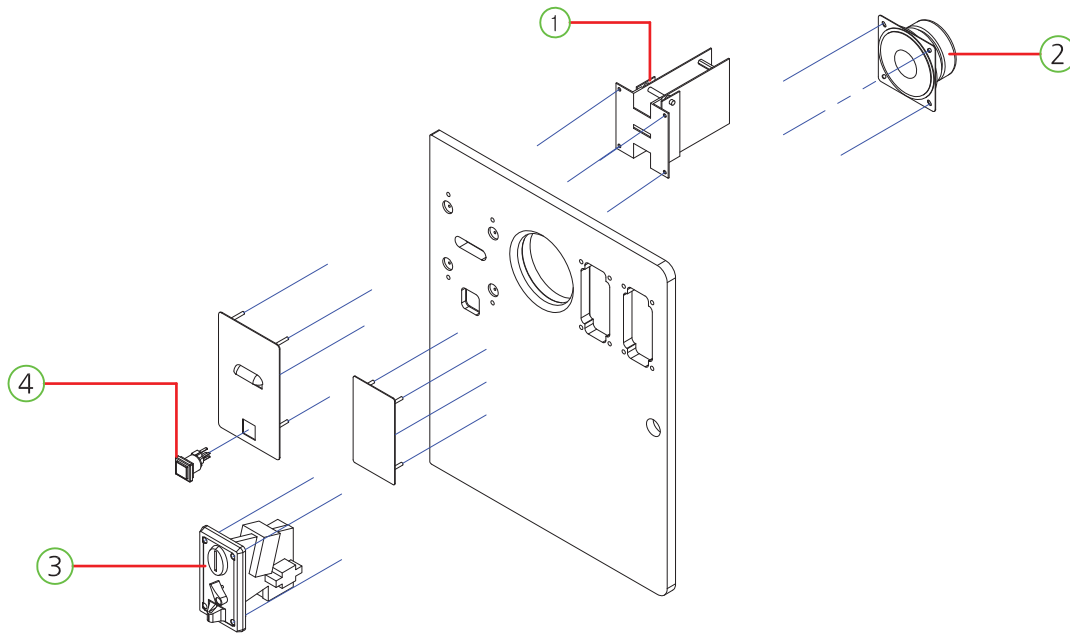

NO.	PART NAME	SPEC.	QUANTITY	CODE NO.
1	TICKET DISPENSOR	CLE CL-002Q-27D	1	MZZZ0TID010
2	SPEAKER	MID4.5"+TW1/2" 8Ω	1	MZZZ0SPE021
3	COIN SELECTOR	TW-389	1	MZZZ0COS052
4	BUTTON SWITCH	TICKET AM 1PB-26SH R12D	1	MMUM0BUT002

5-15. FRONT GLASS DOOR PART

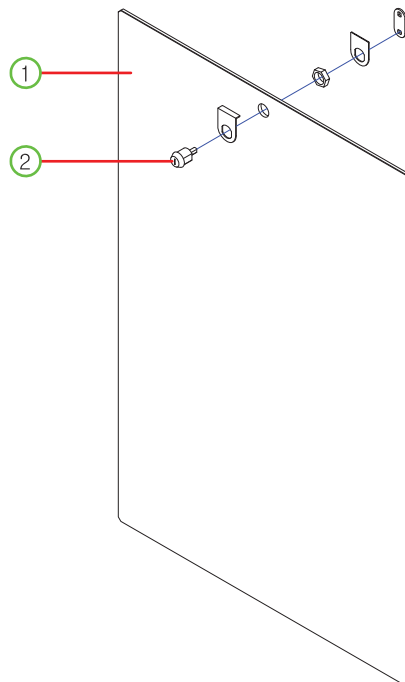

NO.	PART NAME	SPEC.	QUANTITY	CODE NO.
1	FRONT DOOR GLASS	GLASS-5.0t	1	MSSF0GLA001
2	KEY ASS'Y	-	1	MZZZ0KEY076

5-16. MAIN BOARD PCB PART

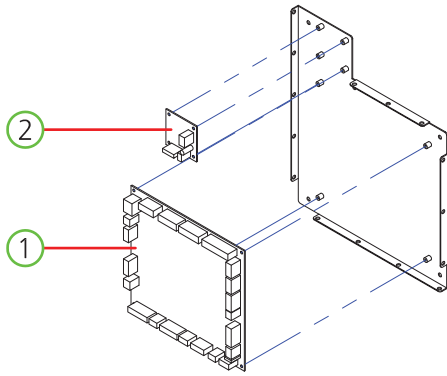

5-17. AC INPUT PART

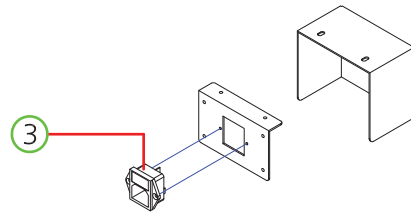

NO.	PART NAME	SPEC.	QUANTITY	CODE NO.
1	ADSTAR MAIN IO PCB ASS'Y	-	1	ASSF0PCB001
2	SOL FET 2CH PCB ASS'Y	12V_2CH	1	AZZZ0PCB203
3	AC INPUT	DAC-13H	1	MELE0SWI015

5-18. SMPS BOX PART

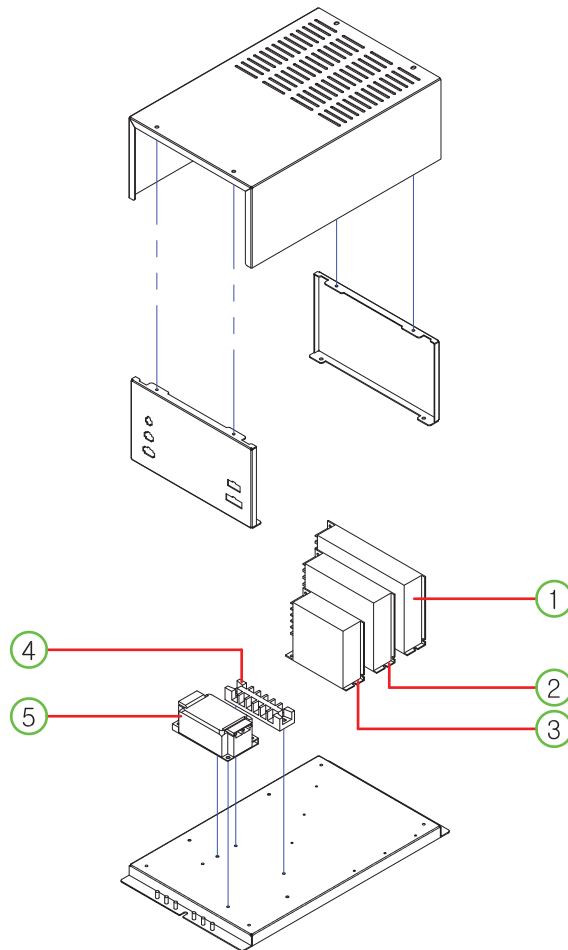

NO.	PART NAME	SPEC.	QUANTITY	CODE NO.
1	POWER SMPS	LRS 150F-24	1	MELE0SMP085
2	POWER SMPS	LRS 150F-12	1	MELE0SMP090
3	POWER SMPS	RS 75-5	1	MELE0SMP040
4	TERMINAL BLOCK	KTB1-020 6P UL_CE	1	MELE0TEB001
5	NOISE FILTER	RNS-2010	1	MELE0NOI009

5-19. MAIN CABINET REAR DOOR PART

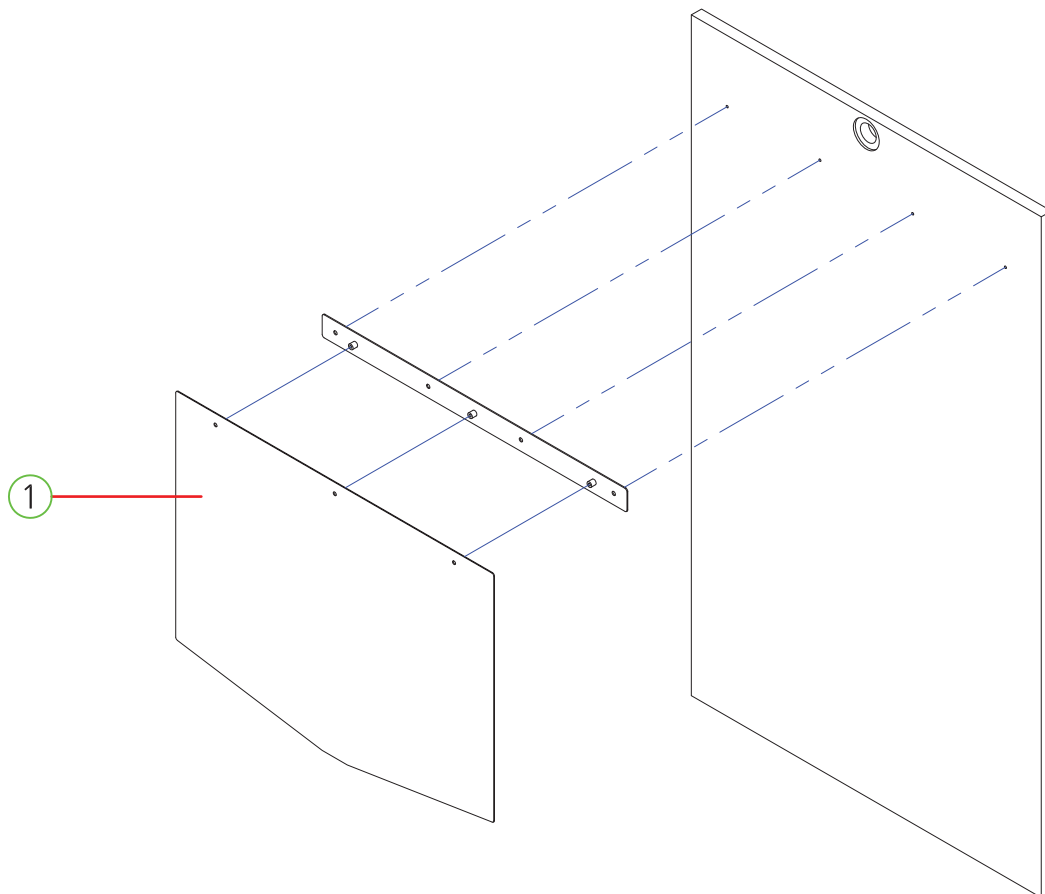

NO.	PART NAME	SPEC.	QUANTITY	CODE NO.
1	REAR DOOR BALL BUFFER PLATE	PC-1.0t	1	MSSF0ACR020

6. WARRANTY ITEM & PART PICTURE

- GOALKEEPER MOVING PART

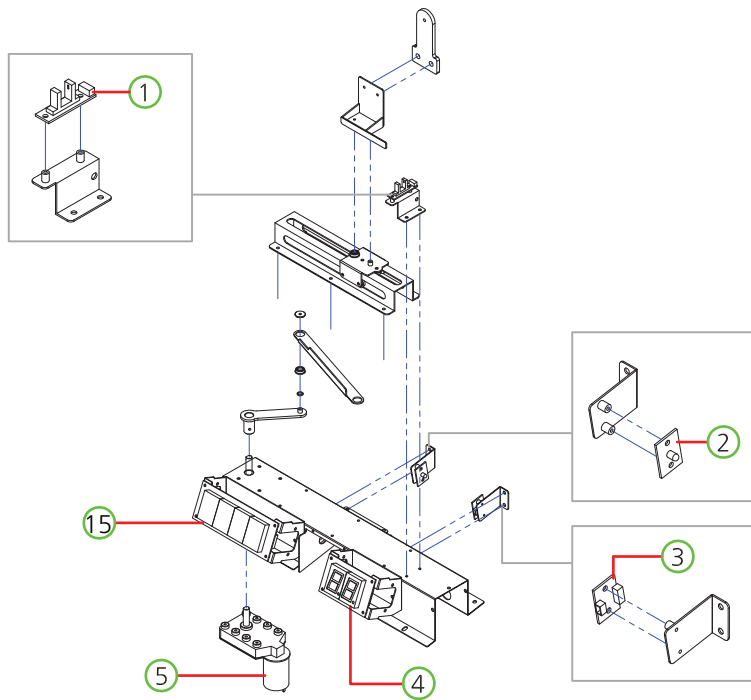

- BALL TRAFFIC JAM PART

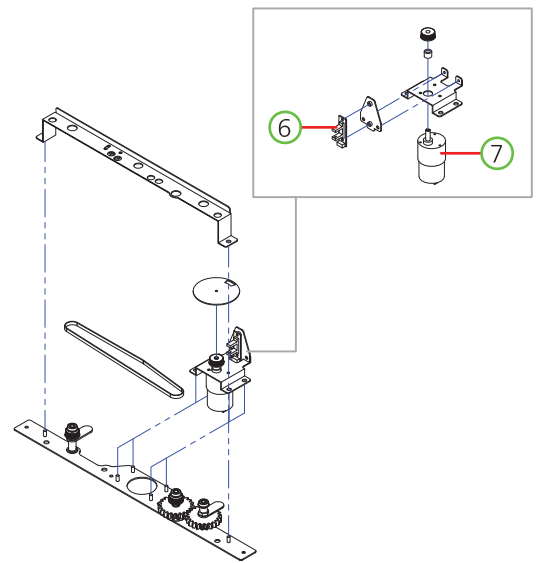

- SOLENOID-1P, 2P PART

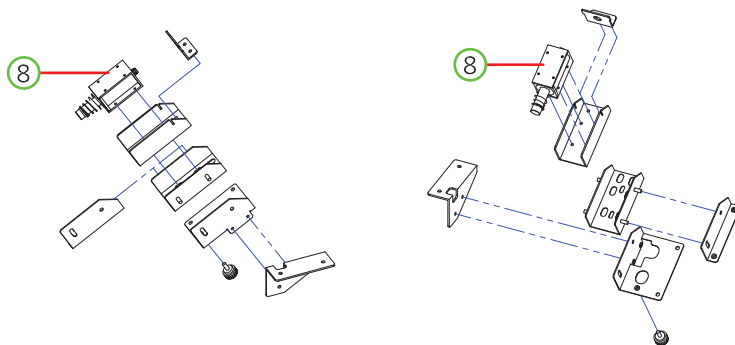

- SETUP PANEL PART

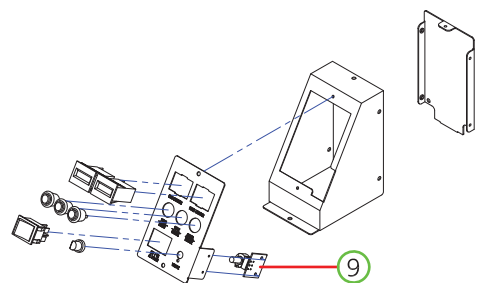

- MAIN BOARD PCB PART

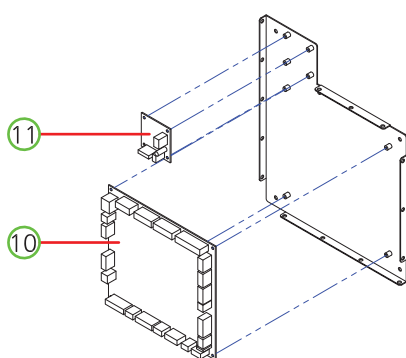



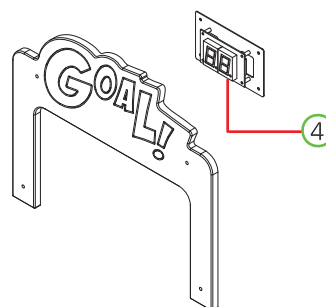

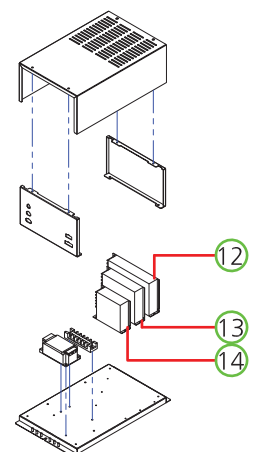

- GOAL POST PART







- SMPS BOX PART



NO.	PIC	PART NAME	SPEC.	QTY	CODE NO.	WARRANTY	
						6 Month	One Year
①	○	PHOTO INT-1 PCB ASS'Y	-	1	AZZZ0PCB103		○
②	○	SENSOR_T PCB ASS'Y	-	1	ASSF0PCB002		○
③	○	SENSOR_R PCB ASS'Y		1	MEIF0PAR014		○
④	○	FND PCB ASS'Y	2941-2(STRAIGHT)	2	AFND0PCB003		○
⑤	○	MOTOR	KGE-3448-050-12V_1/204 F-TYPE	1	MZZZ0MOT072	○	
⑥	○	PHOTO INT-1 PCB ASS'Y	ANGLE TYPE	1	AZZZ0PCB103		○
⑦	○	MOTOR	KGC-0090-3429 50RPM(W/TAP)	1	MZZZ0MOT165	○	
⑧	○	SOLENOID ASS'Y	-	2	ASSF0SOL001	○	
⑨	○	VOLUME PCB ASS'Y	1 VOLUME	1	AHM20PCB016		○
⑩	○	ADSTAR MAIN IO PCB ASS'Y	-	1	ASSF0PCB001		○
⑪	○	SOL FET 2CH PCB ASS'Y	12V_2CH	1	AZZZ0PCB203		○
⑫	○	POWER SMPS	LRS 150F-24	1	MELE0SMP085		○
⑬	○	POWER SMPS	LRS 150F-12	1	MELE0SMP090		○
⑭	○	POWER SMPS	RS 75-5	1	MELE0SMP040		○
⑮	○	FND PCB ASS'Y	2941-4(STRAIGHT)	1	AFND0PCB004		○

1	2	3	4	5	6
					
AZZZ0PCB103	ASSF0PCB002	MEIF0PAR014	AFND0PCB003	MZZZ0MOT072	AZZZ0PCB103

7	8	9	10	11	12
					
MZZZ0MOT165	ASSF0SOL001	AHM20PCB016	ASSF0PCB001	AZZZ0PCB203	MELE0SMP085

13	14	15
		
MELE0SMP090	MELE0SMP040	AFND0PCB004

안다미로 1급 보안 문서
(당사 영업비밀 관리 규정 제27조(벌칙) 관계 법령에 의한 민. 형사상 책임과 사내 규정에 의하여 징계를 받을 수 있음)

MARK	DATE	REVISION
1		
2		
3		

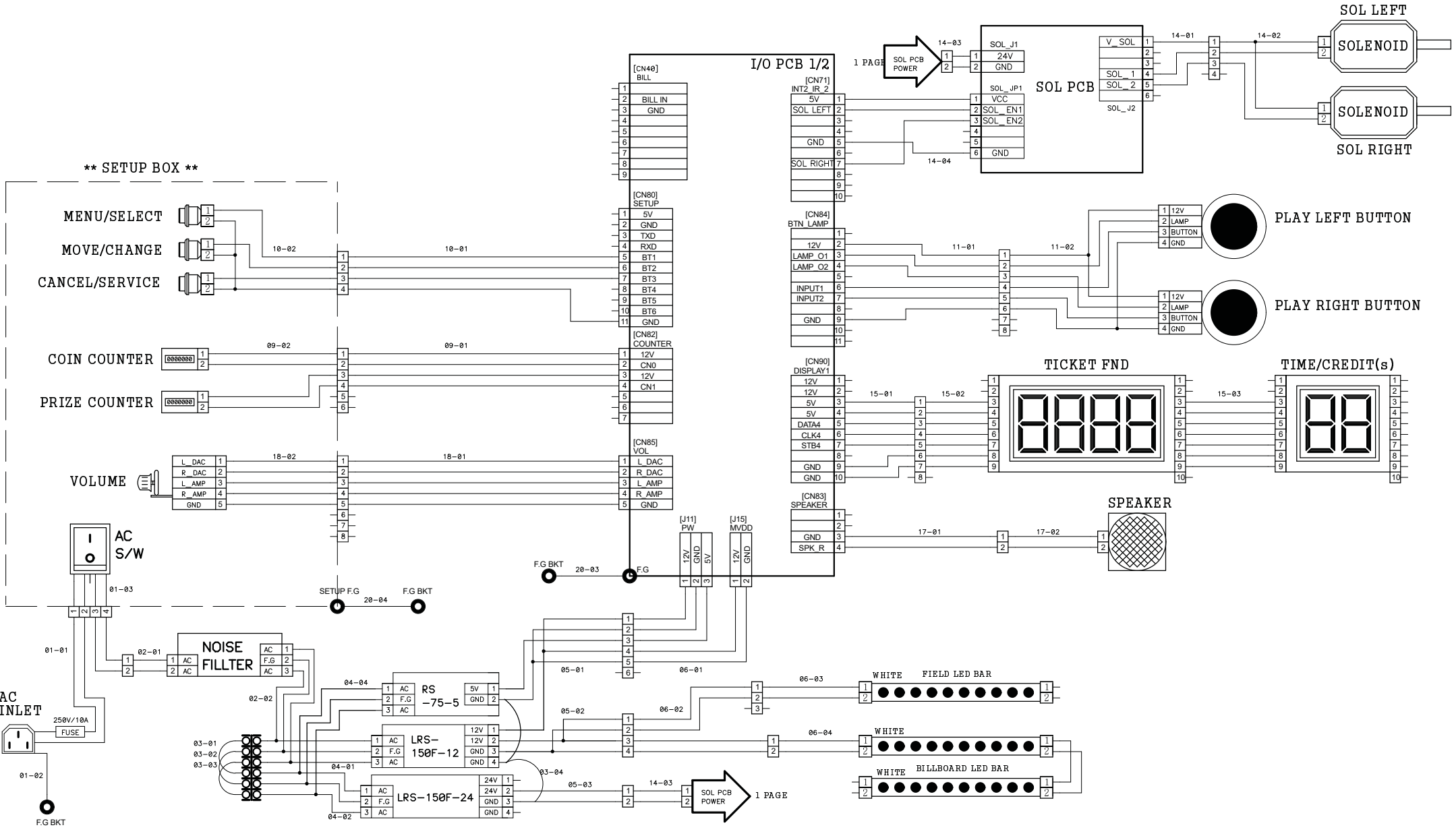

REPRODUCTION, DISTRIBUTION AND UTILIZATION OF THIS DOCUMENT AS WELL AS COMMUNICATION OF ITS CONTENTS TO OTHERS WITHOUT EXPRESS AUTHORIZATION PROHIBITED. OFFENDERS WILL BE HELD LIABLE FOR THE PAYMENT OF DAMAGES. ALL RIGHT RESERVED. COPYRIGHT (c) ANDAMIRO

(복제, 배포 및 사용은 물론, 명시적 허가 없이는 타인에게 내용을 전달할 수 없으며 위반자는 손해 배상 책임을 집니다.)

DEPARTMENT	DRAWN BY	CHECKED BY	APPROVED BY	ITEM	SOCCER SAFARI
H/W	E.S.KIM			NAME	
				DWG.NO	1 PAGE
				CODE.NO	
				DATE	2021.09.30



안다미로 1급 보안 문서
(당사 영업비밀 관리 규정 제27조(벌칙) 관계 법령에 의한 민. 형사상 책임과 사내 규정에 의하여 징계를 받을 수 있음)

MARK	DATE	REVISION
1		
2		
3		

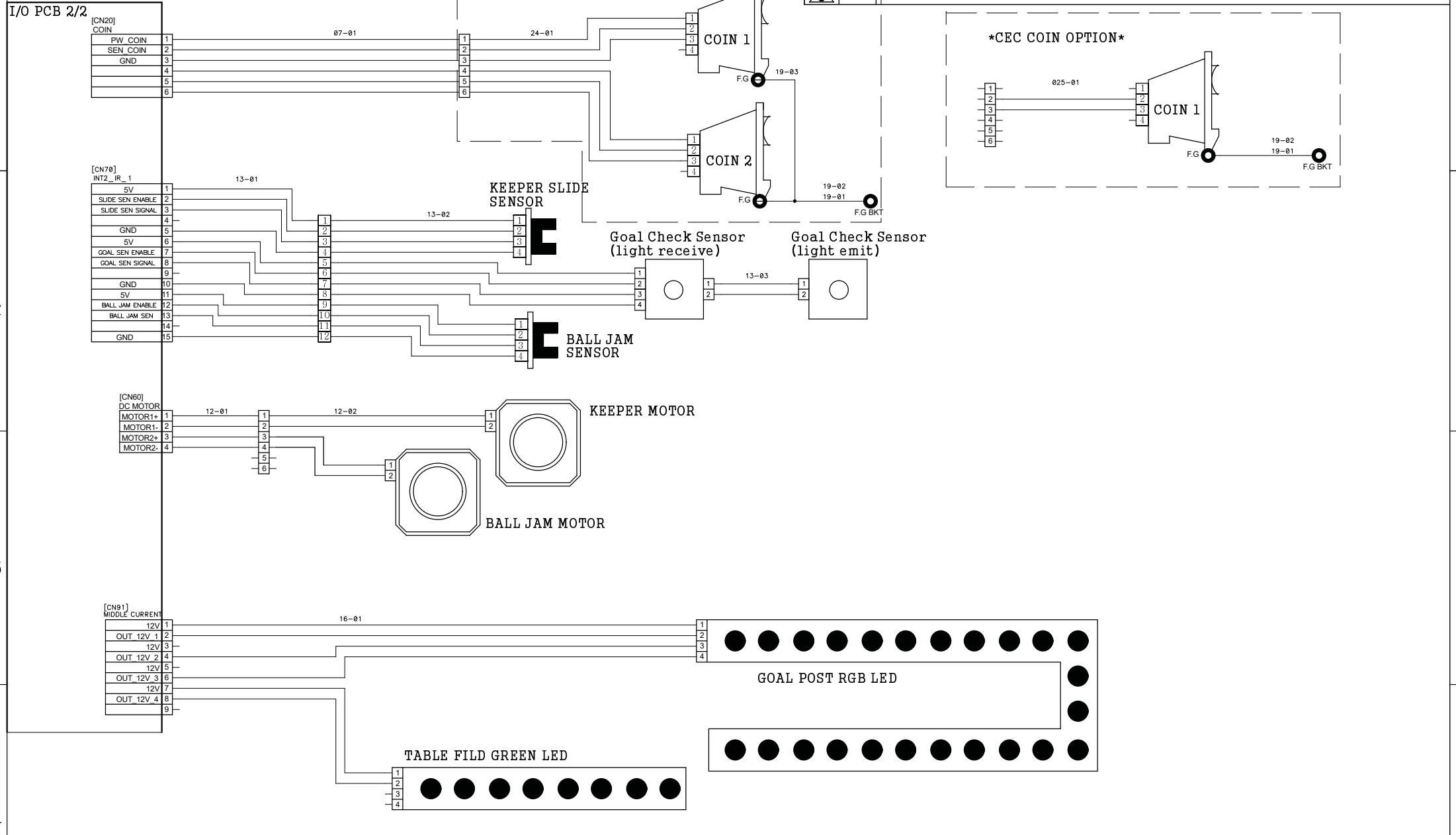

REPRODUCTION, DISTRIBUTION AND UTILIZATION OF THIS DOCUMENT AS WELL AS COMMUNICATION OF ITS CONTENTS TO OTHERS WITHOUT EXPRESS AUTHORIZATION PROHIBITED. OFFENDERS WILL BE HELD LIABLE FOR THE PAYMENT OF DAMAGES.ALL RIGHT RESERVED. COPYRIGHT (c) ANDAMIRO

(복제, 배포 및 사용은 물론, 명시적 허가 없이는 타인에게 내용을 전달할 수 없으며 위반자는 손해 배상 책임을 집니다.)

DEPARTMENT	DRAWN BY	CHECKED BY	APPROVED BY	ITEM	SOCCER SAFARI
H/W	E.S.KIM			NAME	
				DWG.NO	2 PAGE
				CODE.NO	
				DATE	2021.09.30



안다미로 1급 보안 문서
 (당사 영업비밀 관리 규정 제27조(벌칙) 관계 법령에 의한 민. 형사상 책임과 사내 규정에 의하여 징계를 받을 수 있음)

MARK	DATE	REVISION
1		
2		
3		

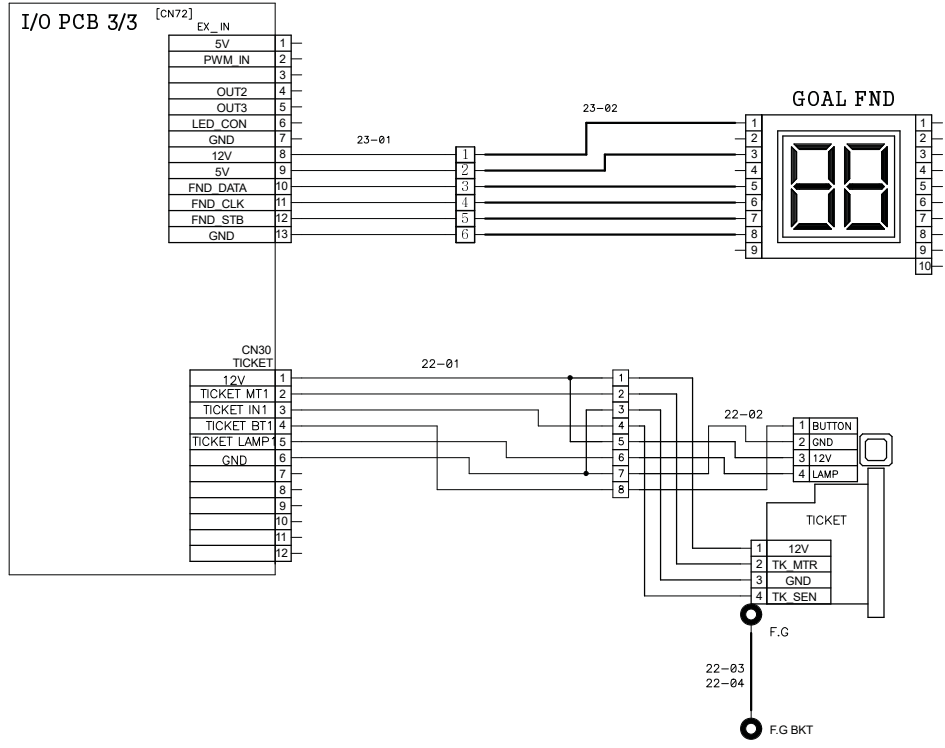

REPRODUCTION, DISTRIBUTION AND UTILIZATION OF THIS DOCUMENT AS WELL AS COMMUNICATION OF ITS CONTENTS TO OTHERS WITHOUT EXPRESS AUTHORIZATION PROHIBITED. OFFENDERS WILL BE HELD LIABLE FOR THE PAYMENT OF DAMAGES. ALL RIGHT RESERVED. COPYRIGHT (c) ANDAMIRO

(복제, 배포 및 사용은 물론, 명시적 허가 없이는 타인에게 내용을 전달할 수 없으며 위반자는 손해 배상 책임을 집니다.)

DEPARTMENT	DRAWN BY	CHECKED BY	APPROVED BY	ITEM	SOCCER SAFARI
H/W	E.S.KIM			NAME	
	ANDAMIRO			DWG.NO	3 PAGE
				CODE.NO	
				DATE	2021.09.30



ANDAMIRO WARRANTY POLICY



Andamiro warrants to the original purchaser that all of its products will be free from defects in material and workmanship.

Andamiro warrants the parts from date of shipment as follows.

- **One Year Limited Warranty : Electronic Boards**
- **6 Months Limited Warranty : Moving Parts**

For any key components within the warranty period, Andamiro will repair or replace defective components free of charge.

When placing a warranty request, the customer is requested to furnish the following information:

1. Name of the game.
2. Serial Number of the game.
3. A Detailed Description of the defect/s experienced.

This warranty does not apply to the defects caused due to misuse or abuse of the product.

Any alterations made to game or game parts will void this warranty.

For warranty details on our product range please visit our website, www.andamiro.com.

ANDAMIRO CO., LTD.
www.andamiro.com





ANDAMIRO CO., LTD.
TEL : 82-31-909-2123~5

[ADDRESS OFFICE] 704-1 Techno Town, 138, Ilsan-ro, Ilsandong-gu, Goyang-si,
Gyeonggi-do, Republic of Korea 10442
[FACTORY] 72 Nochemgil, Ilsan-donggu Goyang-si, Gyonggi-do, 410-834 korea

USA BRANCH
ANDAMIRO USA CORP.
TEL : 1-310-767-5800

[ADDRESS USA] 2222 Century Cir, Irving TX 75062 U.S.A

Homepage <http://www.andamiro.com/>